

MMS

MANUAL

<https://www.sanwa-denshi.com>

SANWA

Safe Handling of Radio and Precautions

In order to use the purchased radio properly and safely, please read this manual thoroughly and make sure to follow precautions. Improper use of the product or negligence of following safety precautions can cause inconvenience to others or harm to the user.

■ For safety, please make sure to follow each of the precautions below.



Warning

Precautions for Installation and Operation

- When turning ON the power switch of radio, please turn on in the order of ① Transmitter → ② Receiver. When turning the power switch OFF, please do so in the order of ① Receiver → ② Transmitter.
 - ☆ If you reverse the order of the switches, it would cause sudden high rotation of the engine and the motor, which is extremely dangerous.

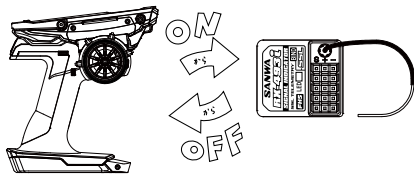

- Please use noise reduction measures on the body of your car.
 - ☆ If metals rub against each other, electrical noise (noise) will be generated and since it will cause abnormal performance, please check that the screw and nut are not loose.
 - ☆ Gasoline engines, motors can also cause noise. Please use a noise reduction measure such as resistive plug with resistor or noise killer condenser.
- Please make sure to run a performance check of the radio (a signal reception test) before the operation. Do not operate it if it is moving abnormally or does not move. Even if the test result on the desk is normal, since the radio wave arrival distance while operating varies depending on the installation method of the receiver, how the antenna is set, the direction of the antenna of the transmitter and geography, please be careful when operating for the first time.

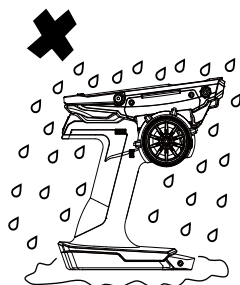

- Never operate on rainy days.
 - ☆ The interior of the transmitter is built with minute delicate electronic parts. If water runs on the surface of the case and enters inside, it can cause abnormal performance or immobility and it can be dangerous.
 - ☆ If the receiver or servo sinks in the water, immediately collect it and dry the interior. When the interior is dry, please submit it to the Sanwa Service for inspection even if it performs normally.
- The receiver is a precise instrument. Please do not cause a strong impact or vibration.
 - ☆ Use a thick sponge to prevent vibrations.
- Install the receiver away from the speed controller, motor and the battery.
- When installing the receiver on a metallic chassis or a carbon chassis, use three layers of double adhesive tape pieces to prevent the receiver from touching the chassis.
- When there is a radio disturbance, change the installation location of the receiver or change from a vertical placement to a horizontal placement or vice versa.
- Do not place a motor cord or a battery cord close to the receiver since it can cause abnormal performance.
- Keep the antenna of the receiver out as much as possible. In addition, keep it straight and stretched. Do not cut the extra length of the line or bend it.
 - ☆ It is dangerous when the antenna is short circuited since the operating range becomes short.
 - ☆ Never cut the antenna.
- Do not place the antenna close to a motor cord or a battery cord.
- Using a conductive piano wire on a metallic chassis or carbon chassis can cause abnormal

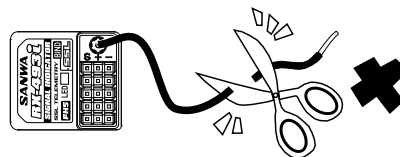

performance from electrical noise. Do not place a piano wire close to the chassis.

! Caution Careful When Driving

When operating RC car etc., be sure to observe the following and be careful not to disturb other people:

- Maintain the car body (chassis) perfectly and check the safety.
- Do not ever run RC car in crowds and roads.
- Always disconnect the power battery connector after running and remove the power battery from the car body.
- In the case of simultaneous running, be sure to determine the controller and follow the instructions.
- Be careful not to disturb the running of other people.
- Be sure to join the RC insurance. Inquire at the radio control pilot registration agency for application for radio control insurance.
- Be sure to add "muffler" (silencer) to the engine that has a silencing effect.
- Avoid starting the engine early in the morning.
- Be sure to clean the running place and then return.

! Caution About Usage

- Do not put to use other than the purpose of model.
- Since this product is manufactured for models based on the Radio Law in each country, it cannot be used in countries other than your original place of purchase.

! Caution Daily Care

- When the exhaust of the engine or fuel is on the radio, wipe it with a soft, dry cloth. When it gets dirty, please wipe it with a tightly squeezed clean soft cloth impregnated with water or neutral detergent. Thinner, benzene, alcohol, motor cleaner, brake cleaner, etc. may cause surface finish to deteriorate or degenerate, so please do not use.

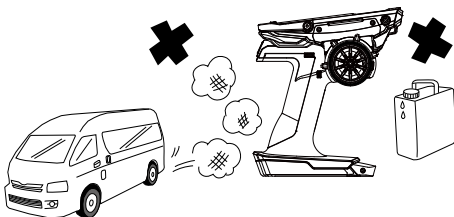

! Caution About Handling Transmitter

- Please do not hit, drop or cause strong shocks. In addition, if you touch the transmitter, receiver, servo, FET speed controller, etc. with hands applied with tire traction agent, it will cause breakdown or case deformation.

! Caution About Storage

- Do not store in following places.
 - ☆ Extremely hot place or extremely cold place.
 - ☆ A place that is exposed to direct sunlight for a long time. Especially if you leave it in a place where direct sunlight hits like in a closed car window, the interior temperature becomes 80 °C or more depending on the season, so please be careful as it may cause deformation or breakdown.
 - ☆ A place with high humidity, poor ventilation.
 - ☆ A place with considerable vibrations.
 - ☆ Places with high dust places subjected to steam or hot air.
 - ☆ A place that gets exhaust gas from an engine or a place near the fuel tank.

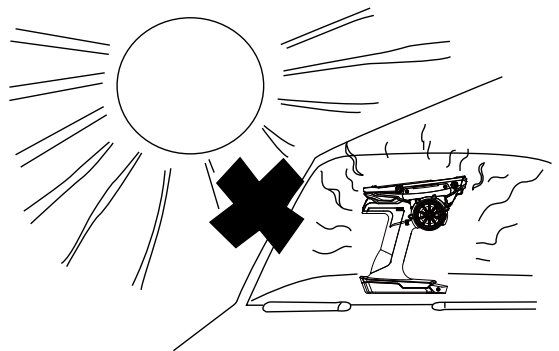

Meaning of the Marks	! Warning	Things you are expected to do to prevent accidents and injuries.
	! Caution	Things that you should follow in order to prevent break down.

Safe Handling of Radio and Precautions



Warning Note Precautions for Safe Use

- 2.4GHz frequency band is not only used for radio control. This frequency band is shared with ISM (Industrial, Scientific and Medical) band. In urban areas, it can be affected by microwave oven, wireless LAN, digital cordless telephone, audio equipment, Bluetooth of game machine or cell phones, and short-range communication such as VICS. Moreover, be careful about being affected by amateur radio and premises radio station for moving body identification, since this frequency band is used for them as well. When harmful radio wave interference is provided to existing radio station, immediately stop the transmission of radio frequency and take measures to avoid the interference.
- For RC circuit, minimise the use of equipment that can affect 2.4GHz system and make sure to check the safety beforehand. Moreover, follow the instructions given by the facility manager.
- When it is to be operated behind the building or steel lower, blocking the direction of radio wave transmission can cause reduction of manoeuvring response or manoeuvring ability. Therefore, always operate within the range that you can visually check.
- Do not attach any metal parts like clip etc. to the built-in part of transmitter antenna.
- If the built-in part of transmitter antenna is extremely close to a servo or speed controller other than the receiver, it can cause malfunction. However, it is an influence of a strong high frequency output and it is not abnormal.
- The receiver is a precise instrument. Do not subject it to strong impact or vibrations. Use the thick sponge to prevent vibrations.
- Keep the antenna wire of the receiver out as much as possible, keep it straight, and stretched. Do not cut or bend the extra length of the antenna line.
- Do not place the antenna wire of the receiver close to noise source like motor code or battery code.
- When installing the receiver on a metallic chassis or a carbon chassis, use by layering with double-sided tape to keep the receiver away from the chassis as much as possible.

INDEX

- [Structure and Standard of Set](#) 6
- [Before Using](#) 7 ~ 13
- [About Connection and Loading of Receiver](#) 14, 15
- [Name of Various Parts of Transmitter](#) 16, 17
- [How to use each feature](#) 18

- [OPERATION OF TOUCH PAD](#) (18)
- [DISPLAY PANEL](#) (19)
- [POWER SUPPLY FORGET ALARM](#) (19)
- [MENU STRUCTURE](#) (20)
- [LAUNCHER](#) (21)
- [MODEL SELECT](#) (21)
- [RX MODE](#) (21)
- [SETTING](#) (22 - 33)
- [DUAL RATE \[D/R\]](#) (22)
- [SPEED](#) (23 - 33)
- [CURVE](#) (26 - 31)
- [FAIL SAFE \[F/S\]](#) (32)
- [BASE](#) (33 - 35)
- [TRIM](#) (36 - 38)
- [FEELING](#) (39)
- [THROTTLE TYPE \[TH TYPE\]](#) (39)
- [ANTI-LOCK BRAKE \[ALB\]](#) (40)
- [OFFSET](#) (41)
- [AUX](#) (42 - 47)
- [STEP AUX](#) (42)
- [POINT AUX](#) (42)
- [4WS-MIXING](#) (43)
- [MOA-MIXING](#) (44)
- [BR-MIXING](#) (44)
- [DUAL STEERING](#) (45)
- [BOAT](#) (46)
- [CODE AUX](#) (47)
- [MIXING](#) (48 - 50)
- [C-MIX1 ~ 5](#) (48, 49)
- [TANK](#) (50)
- [LIMITER](#) (51)
- [TIMER](#) (52 - 57)
- [SETUP](#) (53)
- [LAP TIMER](#) (54)
- [INTERVAL TIMER](#) (55)
- [DOWN TIMER](#) (56)
- [RACING MODE FUNCTION](#) (57)

- [TELEMETRY](#) (58 - 70)
- [LOG DATA](#) (59 - 64)
- [TELEMETRY SETTING](#) (65)
- [INDICATOR](#) (66)
- [GRAPH SETTING](#) (67)
- [TELEMETRY SWITCH](#) (67)
- [TELEMETRY MIXING](#) (68)
- [RX MODE SETTING](#) (69, 70)
- [MODEL](#) (71 - 77)
- [MODEL SELECT](#) (71)
- [QUICK SETUP WIZARD](#) (72 - 73)
- [MODEL NAME](#) (74)
- [MODEL COPY](#) (75, 76)
- [MODEL MOVE](#) (77)
- [MODEL CLEAR](#) (78)
- [DIRECT MODEL SELECT \[D-MODEL SELECT\]](#) (79)
- [SYSTEM](#) (83 - 99)
- [BIND](#) (83 - 99)
- [KEY ASSIGN](#) (83, 84)
- [CUSTOM LIST](#) (85)
- [AUX TYPE](#) (86)
- [RACING MODE](#) (87)
- [SERVO MONITOR](#) (88)
- [BATTERY](#) (89)
- [SOUND](#) (90)
- [LCD](#) (91)
- [LED](#) (92)
- [CLOCK](#) (93)
- [CALIBRATION](#) (94)
- [TOUCHPAD](#) (95)
- [USERNAME](#) (96)
- [SETUP](#) (97)
- [SD CARD](#) (98)
- [FACTORY-RESET](#) (99)
- [MULTI SETTING GEAR](#) (100 - 105)
- [MOTION STEERING](#) (106)

- [List of Assign Functions](#) 107 - 108

Structure and Standard of Set

Structure of Set

	PC, primary components
<A>Transmitter	M17S
Receiver	RX-493i
<C>Servo	—
<D>Accessories	Strap hook x 1 Large steering wheel x 1 Spring [Super soft (SS) / soft (S) / medium (M) / hard (H)] x 1 each Steering swing spacer [R/L/ x 1 each Trigger angle spacer x 2 Brake trigger [+1 / +2] x 1 each Grip pad [Small (S) / large (L)] x 1 each Li-Po battery for transmitter (LP1 – 2500) x 1 BIND plug x 1 Dust cover for receiver x 1 Antenna Pipe x 1 Screen Protector x 1 User manual (Quick Reference) x 1

● Check contents of the set before use.

Standard of Set

<A>Transmitter

Model	M17S
Output display	Digital / analogue display (power supply voltage display)
Modulation system	2.4 GHz spectrum spread system
Power supply	Li-Po1 cell (corresponding voltage DC 4.2V)
Weight	510 g

Receiver

Model	RX-493i
Modulation system	2.4 GHz spectrum spread system
Dimensions	26.0x23.2x14.0mm
Power supply	DC3.7~7.4V
Weight	6.2 g

※ Check input voltage. The transmitter gets severely damaged if a voltage above permitted voltage is input.

Before Using

About Power Supply

- Carefully read the following charging method and points of caution for correct and safe use.
- Always charge before using.
Li-Po battery has many merits such as it has higher capacity than the conventional chargeable batteries, is lightweight and has low natural discharge. However, it deteriorates quickly if handled incorrectly and may produce smoke and catch fire. Always observe the following points of caution and use safely.
 1. Do not ever short plus and minus terminals. (There is fear of smoking, catching fire if shorted.)
 2. Do not charge by connecting the charger to the Z connector that connects to the transmitter main body.
 3. Do not ever dismantle battery or reconstruct connector.
 4. Do not use if battery main body or insulation of cable is damaged.
 5. When removing the battery from the transmitter main body, always pull by holding the connector.
 6. Discontinue use and immediately charge when the battery voltage lowers below 3.3 V.
 7. This product has an in-built charging circuit with charging current of 800 mAh. In case of charging, use USB AC adapter having output above 5V 1000 mAh.
 8. At the time of charging, always switch OFF the power supply of transmitter.
 9. Do not store in a place receives direct sunlight for a long period. The temperature goes above 80° C. It may cause to be deformation or failure.
 10. In case of storing for a long period, take out from the transmitter and store. Store in a dark place by keeping in a safety bag. Charge the battery about 50 % once in 3 months.
 11. Do not store with battery and USB AC adapter in a connected state.
 12. If used in the over-discharged state (below 3.3 V), battery rapidly deteriorates and expands. Discontinue use of the swollen battery immediately.
 13. Dispose of the deteriorated battery as per local rules.
- ※ While inserting into the transmitter, take care wire of the battery does not get caught in the battery cover.
- ※ Overcharged battery not only gets damaged but also may cause burning, fire, injury, blindness due to abnormal heating, tearing, leakage etc.
- ※ Do not use the deformed or swollen battery.
- ※ Do not throw in such a manner that causes a strong impact.

About Charging of Transmitter Battery

- 1) Connect USB AC adapter to outlet plug of AC100V.
※ Compatible micro USB connector is [Type-C (USB A to USB C cable)].
※ The battery (LP1-2500) is not compatible with USB PD (USB POWER DELIVERY). The battery cannot be charged by USB PD.
- 2) At the time of charging transmitter battery, open the connector cover of the transmitter and connect the micro USB connector to the battery.
- 3) Check that battery LED light that can be seen from battery port is turned on.
- 4) Charging completes when battery LED light changes to green. After complete charging, remove micro USB connector from the battery.
※ After complete charging, remove USB AC adapter from AC 100V outlet plug.
※ Do not store with the charger connected to the battery.
※ If not using for a long period, charge the battery 50 % once in 3 months.
※ Micro USB cable (Type-C) for charging does not come as an accessory.
※ In case of taking off a battery cover, slide the battery cover with fully open a battery access cover. In case of not fully open the cover, the cover will be broken.

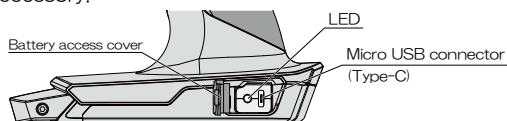

About Micro SD Card

- M17S is compatible with micro SD card. Use Sanwa genuine or card formatted to FAT32. Model data or telemetry data can be stored by the use of micro SD card. Firmware update becomes possible by the use of micro SD card when the firmware update of M17S is published.
At the time of inserting the micro SD card, insert with the metal terminal surface on the upper side.
- Upon inserting the micro SD card, a folder named "M17S" is created and a folder named "MODEL" is created in this folder and model data is stored in it.
Upon exporting the log data, a folder named "Log" is created and "csv" data is stored in this folder.

Before Using

Design Adjustment of Steering and Throttle

In M17S, not only can the design of steering / throttle trigger be adjusted but also details can be matched as per liking of the user based on adjustment of left-right driving position and steering swing, adjustment of trigger position, trigger angle, brake trigger by detachable throttle unit and fully adjustable trigger, replacement of spring of throttle trigger and replacement of grip pad.

Design Adjustment of Steering

Spring position of steering can be adjusted by inserting a hexagonal wrench driver (1.5 mm) at the location shown by the arrow in the figure on the right and turning it. Please take care of too much tight or loose.

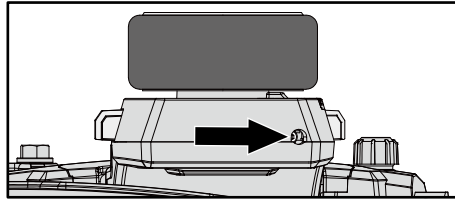

Adjustment of Design of Throttle Trigger

Spring position of throttle trigger can be adjusted by inserting a hexagonal wrench driver (1.5 mm) at the location shown by the arrow in the figure on the right and turning it. Please take care of too much tight or loose.

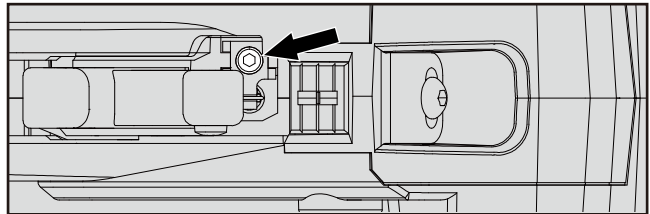

Replacement of Steering Spring

In M17S, steering spring can be easily replaced. Replace with spring of your choice. At the time of shipping, steering spring becomes soft and it can be chosen from Super soft (SS) / medium (M) / hard (H).

- 1) Remove the steering wheel.
- 2) Remove the beads for fixing spring hatch.
- 3) Remove the spring hatch and replace with steering spring having a hardness of your choice.
- 4) Attach the spring hatch and the beads for fixing.
- 5) Fix the steering wheel.

※ Take care that the direction of the wheel adapter is correct.

※ About selection of spring
Hardness of the spring can be selected as per colour. Super soft (purple), soft (black), hard (blue) and normal is colourless.

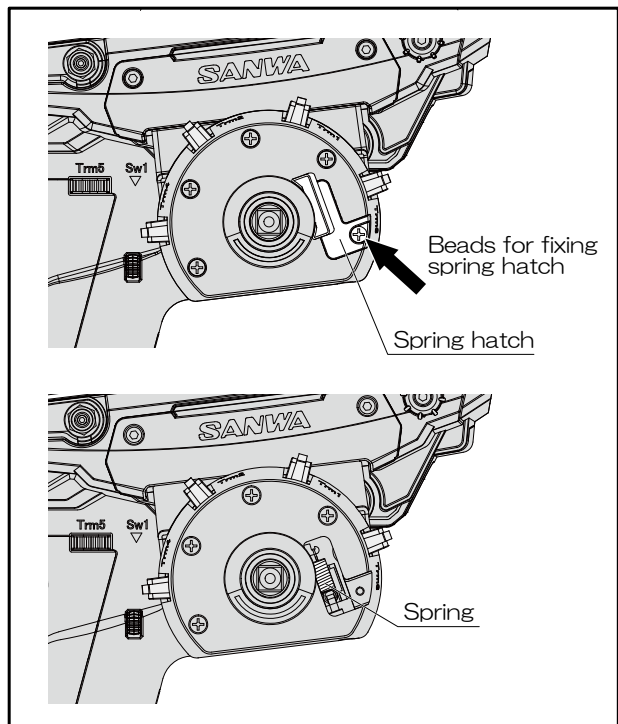

Replacement of Throttle Spring

In M17S, the replacement of steering as also the replacement of throttle spring is easy. Replace with the spring of your choice.

At the time of shipping, spring becomes soft and it can be chosen from super soft (SS) / medium (M) / hard (H).

- 1) Remove the beads for fixing detachable throttle unit on the back side of the transmitter.
- 2) Pull out the detachable throttle unit from the transmitter. Also, pull out cable of the throttle unit at this time.
- 3) Replace the spring at the centre of the throttle unit with the spring of your choice.
- 4) After completing replacement of the spring, mount the detachable throttle unit onto the transmitter main body while housing the cable such that it does not entangle and fasten the fixing beads.

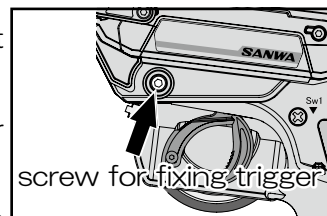

※ About selection of spring
Hardness of the spring can be selected as per colour. Super soft (purple), soft (black), hard (blue) and normal is colourless.

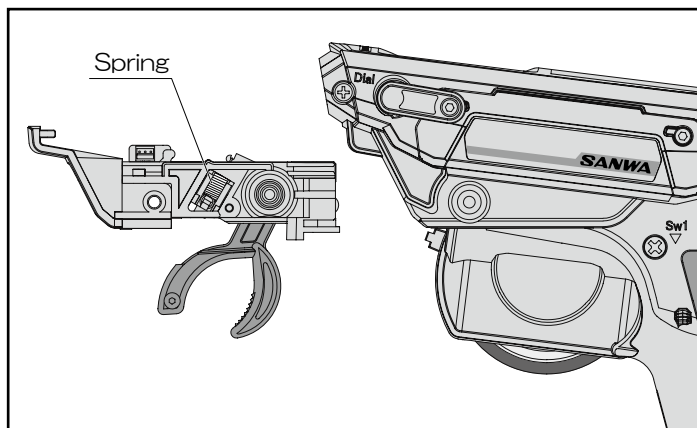

Adjustment of Grip Pad

In M17S, grip pad can be replaced. Replace the grip pad as per the size of the hand of the user. Grip pads are of 2 types namely small/large. (At the time of shipping, normal is mounted.)

Packing (17 locations) of the grip pad is locked to the grip part of the transmitter. Hence, do not pull it out.

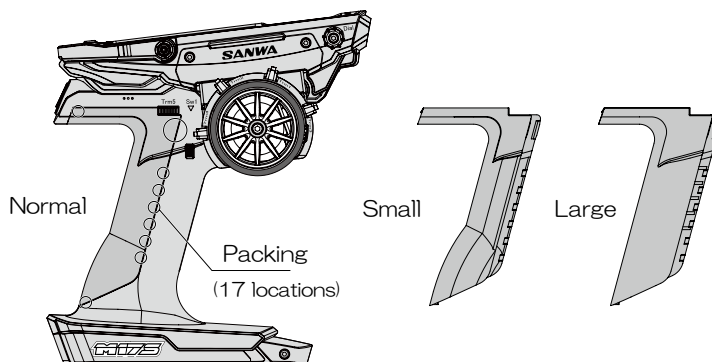

Before Using

Before start using

Adjustment of Full Adjustable Trigger

Adjustment of Trigger Position

Loosen the screw for fixing trigger on the back side of the transmitter.

Next, adjust the screw for trigger position adjustment present on the side surface of the transmitter and set the trigger at the desired position.

The trigger position gauge moves to (A) direction on turning the screw for adjusting trigger position in () manner. It moves to (B) position on turning the screw for adjusting trigger position in () manner.

※ The movement range of trigger is 5 mm. If the adjustment screw is turned exceeding the range, it may cause damage. Be careful.

After setting the position of the trigger, fasten the trigger fixing screw. This completes the adjustment of the trigger.

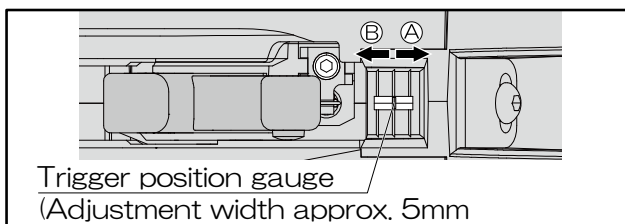
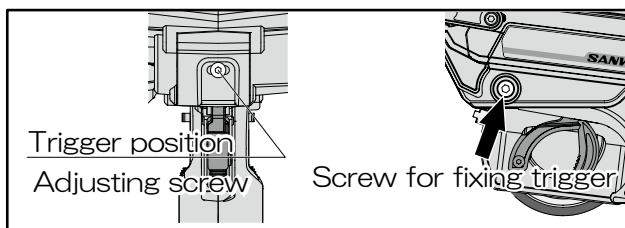

Adjustment of trigger angle

The angle of the throttle trigger can be adjusted in 5 stages by replacing angle spacer A/B/C.

1) Remove the screw for fixing trigger present on the back side of the transmitter.

2) Change the direction of the angle spacer such that easily operatable angle is set and adjust the angle.

3) After deciding the angle of the trigger, fix the screw for fixing the trigger present on the back side of the transmitter.

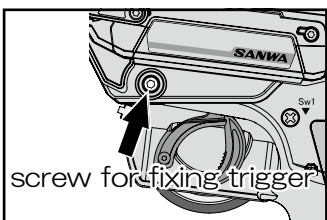
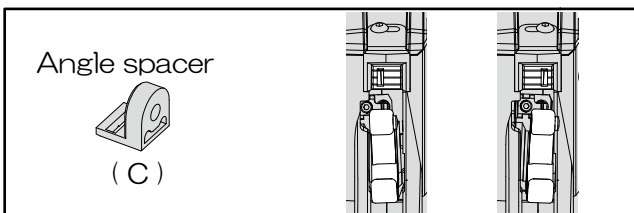
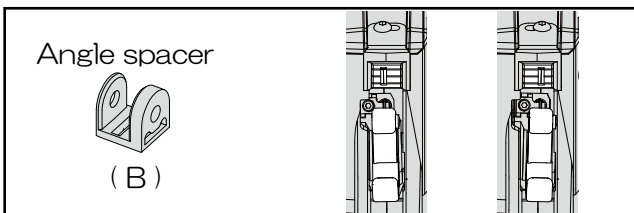

Adjustment of brake trigger

Grip tool can be adjusted as per the size of the hand or your choice by replacing brake trigger. Brake trigger can be chosen from 2 types namely +1 and +2 other than standard size mounted at the time of shipping.

1) Remove the brake trigger fixing screw present on the backside of the trigger.

2) Select the brake trigger as per the size of the hand or your choice.

3) After deciding the brake trigger to be used, fix by using the brake trigger fixing screw.

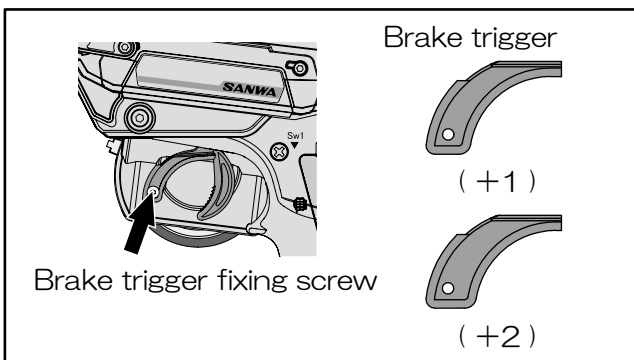

Adjustment of Driving Position

Adjustment of Steering Swing Spacer

● The angle of the steering unit can be adjusted by using the steering swing spacer.

- 1) Remove 2 screws that fix the front cover and remove the front cover.
- 2) Remove 4 screws that fix the steering unit.
- 3) Remove the steering base from the steering unit and replace the steering swing spacer and fix the steering base to the steering unit.
- 4) Fix the steering unit to the transmitter main body.
- 5) Fix the front cover. This completes adjustment of steering swing spacer.

Before start using

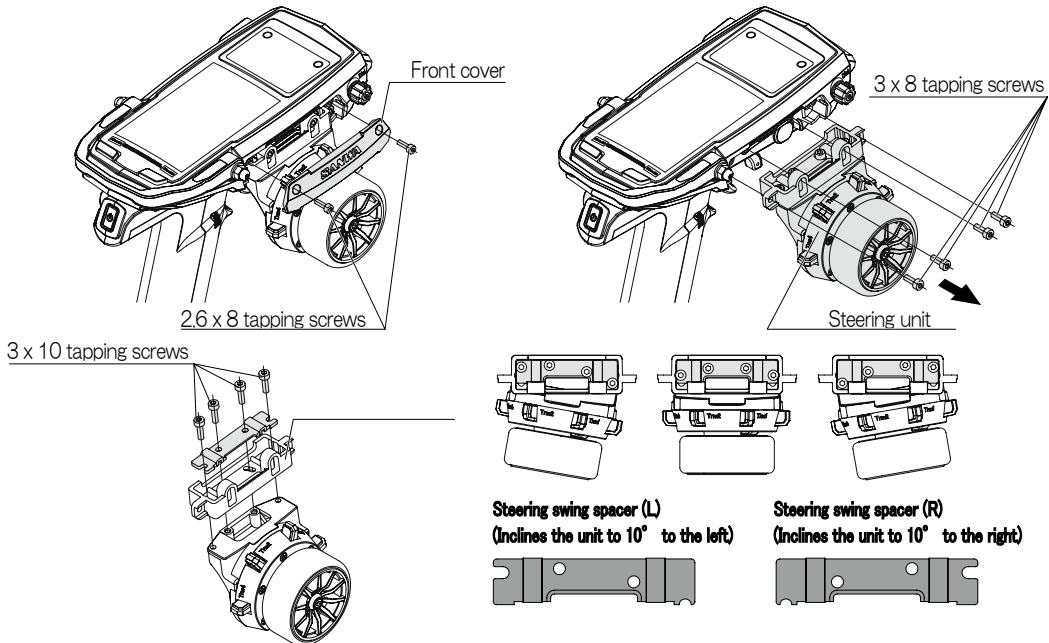

About Strap Hook

- Remove M3 hollow bead of carrying handle nut tip and attach the provided strap hook.
- ※ If rattle sound of strap hook is noticed, paste the provided sponge to the hook and use.

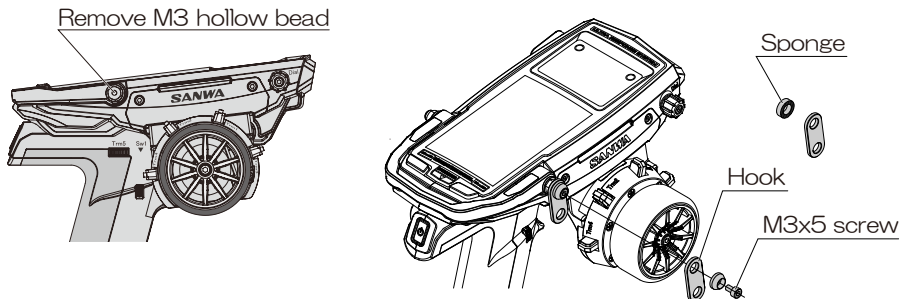

Before start using

Adjustment of Left Right Driving Position

● If left handed, it is recommended to change left-right driving position.

1) Remove 2 screws that fix the front cover and remove the front cover.

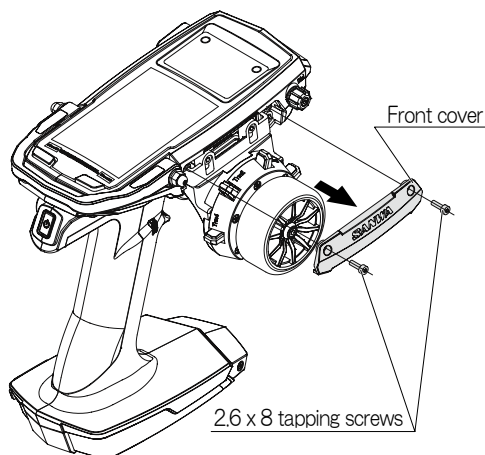

2) Remove 4 screws that fix the steering unit and remove the connector of steering unit and wiring of steering unit from the main body.

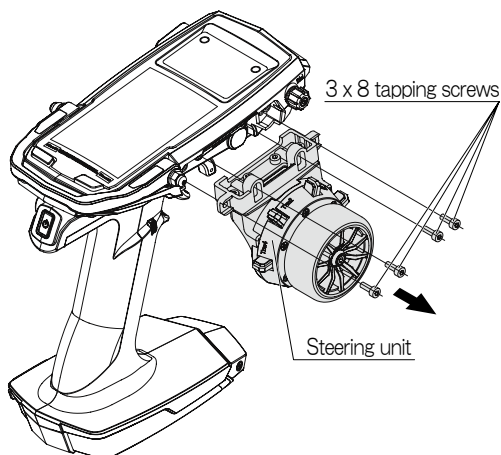

3) Fix the dial shaft using a hexagonal wrench driver (1.5 mm). Remove the screw that fixes the dial and remove the dial.

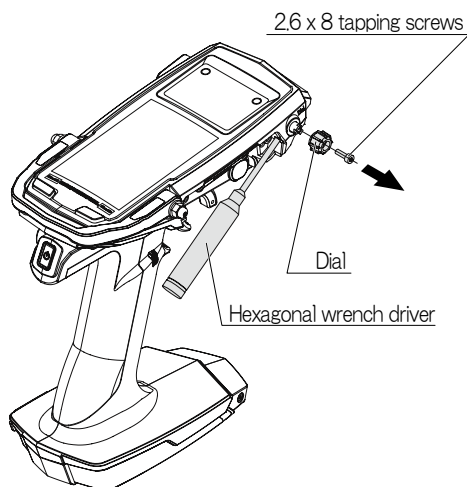

4) Remove 2 screws that fix the rear cover and dial shaft cover and remove the rear cover and dial shaft cover.

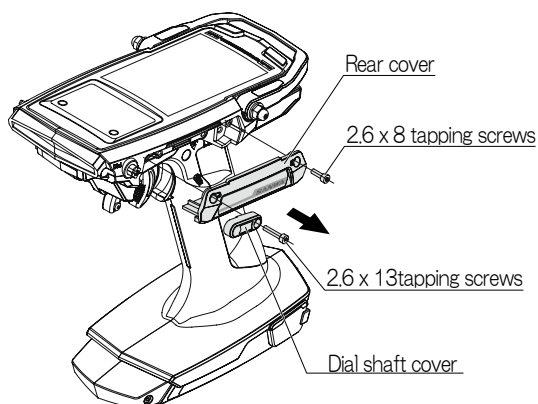

5) Attach the removed rear cover and dial shaft cover used as an accessory to the right position. (There are 2 types of dial shaft covers.)

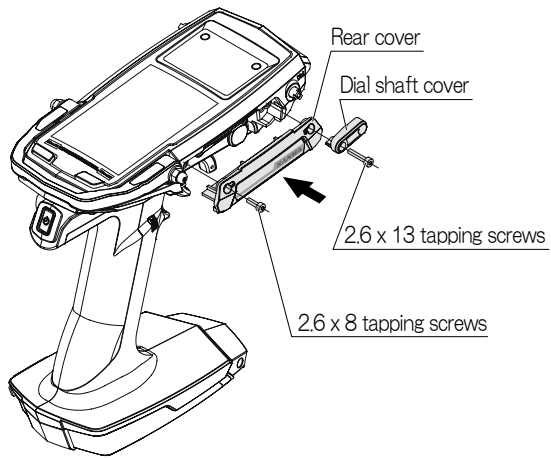

6) Fix the dial to the left position, connect the connector such that direction is correct and fix the steering unit.

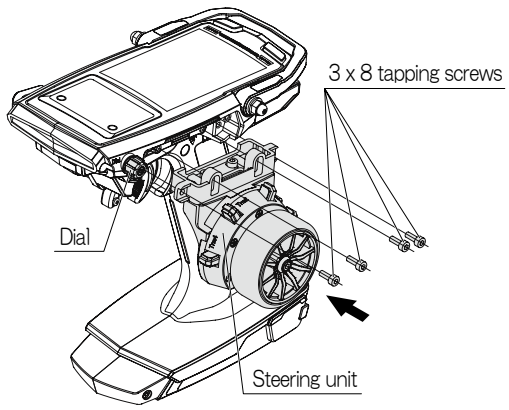

7) Fix the front cover. Left-right change switch is on the inner side of the grip pad. Hence, change the change switch from [R] to [L] and attach the grip pad.

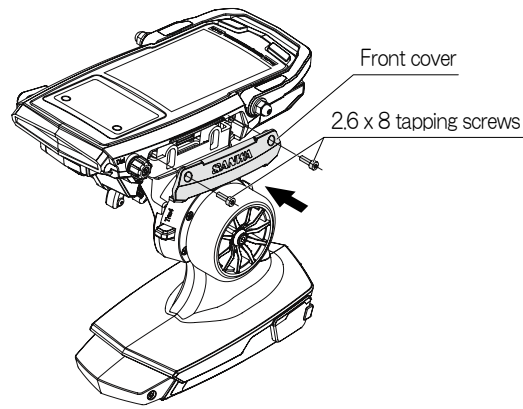

8) Change [HANDEDNESS] (left-right change menu) of [SETUP] of SYSTEM menu from [RIGHT] to [LEFT]. (P.102)

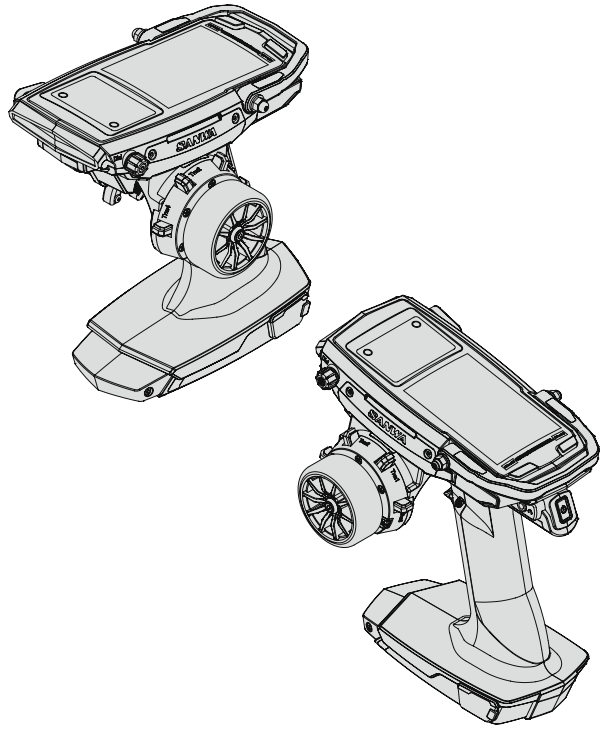
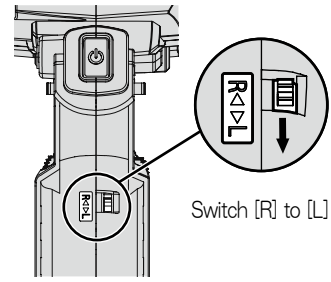

About Connection and Loading of Receiver

About Receiver

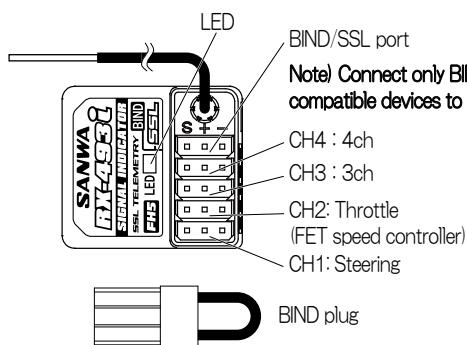

State of receiver LED

State of receiving electromagnetic waves	Blue light on
State of not being able to receive electromagnetic waves	—
During BIND (bind) setting	Blue light blinking Blue light speedy blinking
Battery failsafe operation	Blue & red light on
State of not being able to receive electromagnetic waves after battery failsafe operation	Red light on

● About RX-493i

- RX-493i can store 2 IDs. It can be combined with M17S having a matching position or setting such as endurance race etc.

It can be operated with 2 bound transmitters based on storing IDs specific to 2 transmitters.

(2 transmitters cannot be operated simultaneously.) It is compatible with M17S, M17, MT-5, MT-R.

- Neutral position of the throttle and operating volume may vary depending on each transmitter. The set value of the transmitter may not be the same as per combination of the bound transmitter. Adjust using the transmitter that matches with the linkage of the car.
 - Connect the compatible device to SSL port in case of changing the setting of SSL compatible device in real time by using CODE AUX of M17S.
 - Always do the failsafe setting by the respective transmitter.
 - Do the same setting for RF MODE and response mode of 2 M17S to be bound. Binding by 2 transmitters is not done if they do not have the same setting.
- ※ If transmitter having different setting is bound as a 2nd transmitter, ID (identification number) of M17S bound to the 1st transmitter gets deleted and overwritten.
- ※ ID of the 1st M17S gets deleted if binding of the 3rd transmitter is done.
- ※ When using first time, the M17S and RX-493i are not binded. Please bind before using.

About Handling of Antenna

- Reception distance varies depending on the location at which receiver and antenna are loaded.
- As shown in the figure on the right, in order to protect the antenna, always insert the antenna into the antenna pipe such that tip of the antenna does not come out from the external part of the antenna pipe.
- Do not ever bend the antenna as it may break internally.
- Do not unnecessarily pull the antenna. It may cause damage to the internal parts of the receiver.
- At the time of loading onto the RC car, arrange the antenna at the higher possible position.
- Do not cut or tie the antenna as this may cause lowering of the reception sensitivity.
- Erect the antenna of the receiver vertically, away from the motor and FET speed controller (including wiring).

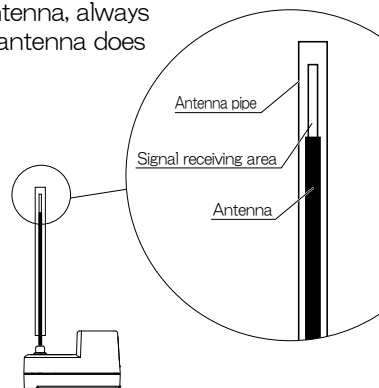

About Connection and Loading of Receiver

About connection

- Connect the receiver and servo by referring to the following figure.
- Connection example in case of using in EP car

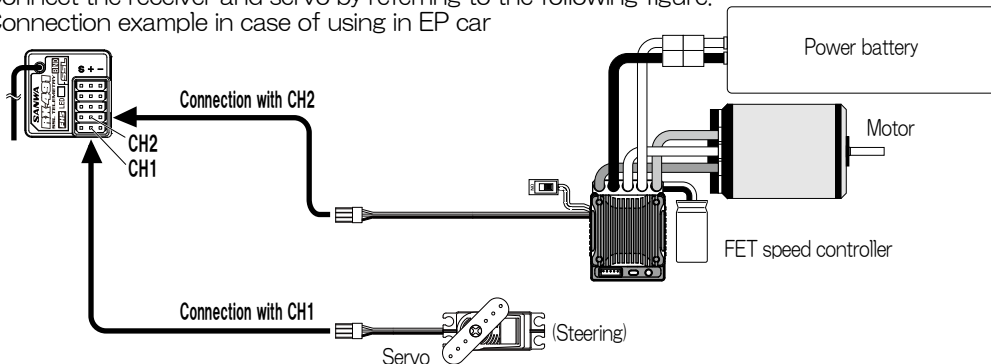

- Connection example in case of using in Nitro car

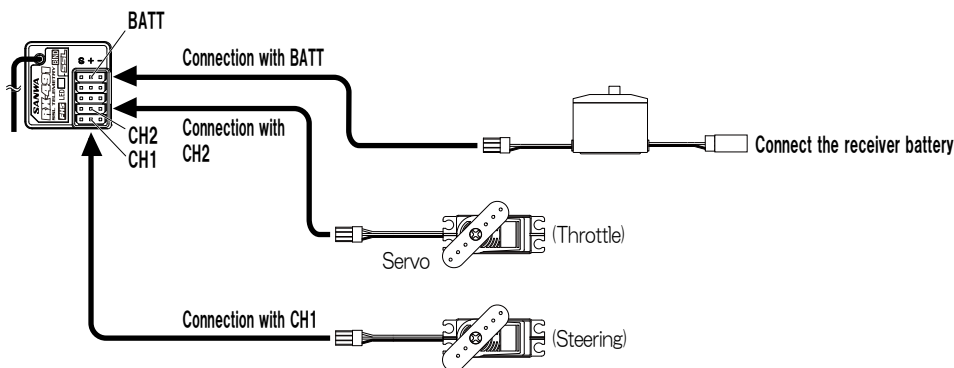

■ Case of connecting PGS servo and SUPER VORTEX Gen2/PRO/D2/SUPER VORTEX Stock to SSL port

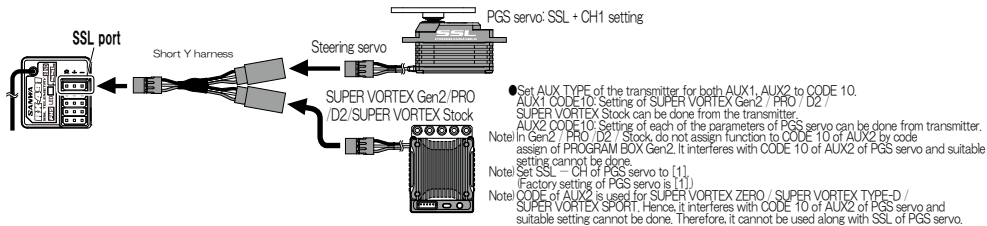

■ Case of connecting PGS servo to 2 SSL ports

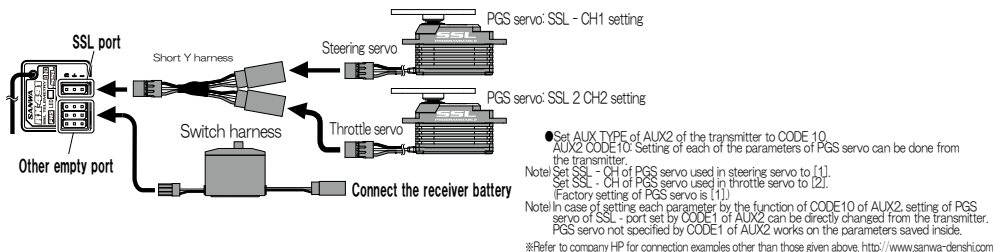

- Caution**
- There is risk of explosion if the connector slips out due to vibrations during running. Firmly connect the connector of receiver, servo and switch.
 - Take proper anti-vibrations / waterproof measures since the receiver has poor resistance to vibrations, impact and water.
 - There is risk of explosion if proper measures are not taken.
 - Mount the receiver away from carbon chassis and metal chassis.
 - If metal parts loaded onto RC car touch each other, noise is generated which affects the reception efficiency adversely and it may cause explosion.
 - Always use a noise killer capacitor in the brush motor used for generator RC car.
 - Noise is generated which may cause explosion if noise killer capacitor is not attached.
 - Use SANWA official transmitter parts such as transmitter, receiver, servo, FET speed controller, transmitter battery etc.
- ※ The company does not bear any responsibility for any damage occurred due to use, reconstruction, adjustment or part replacement with parts other than SANWA official parts.

Name of Various Parts of Transmitter

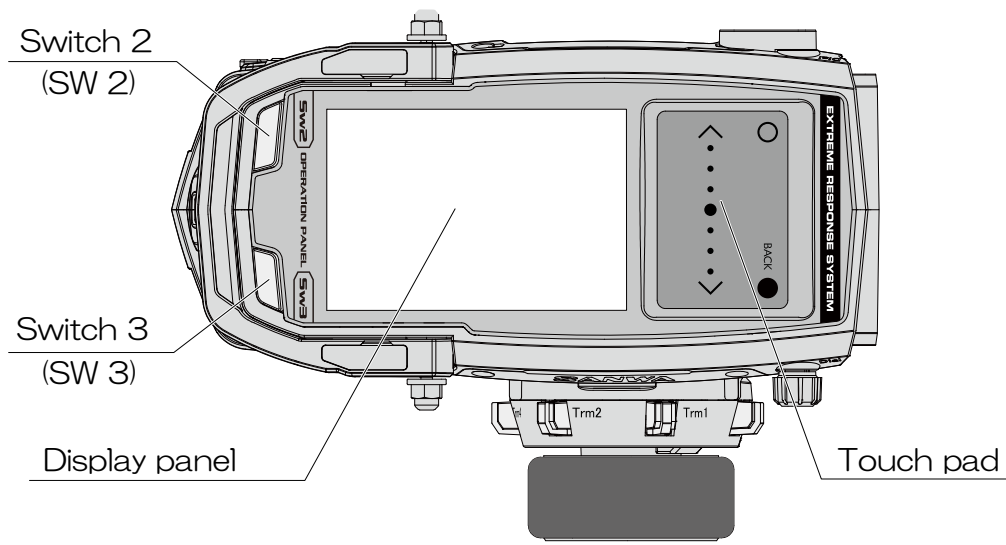
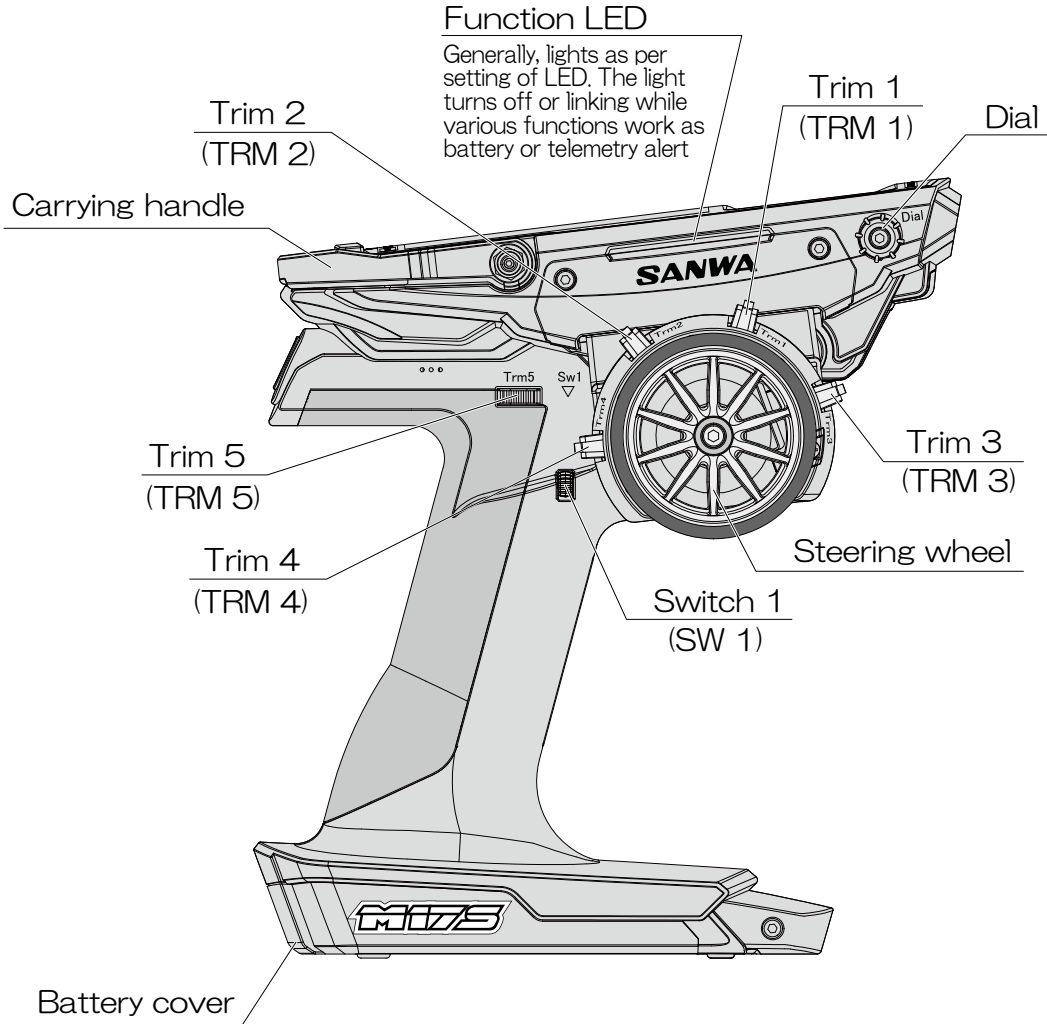

Name of Various Parts of Transmitter

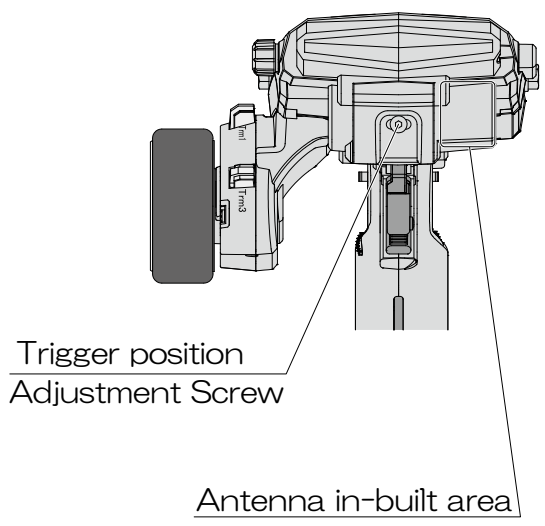
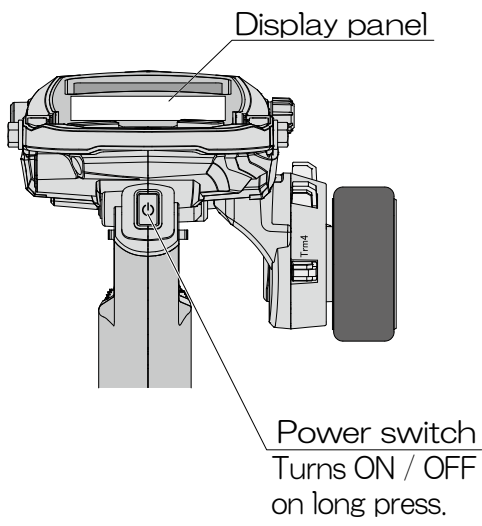
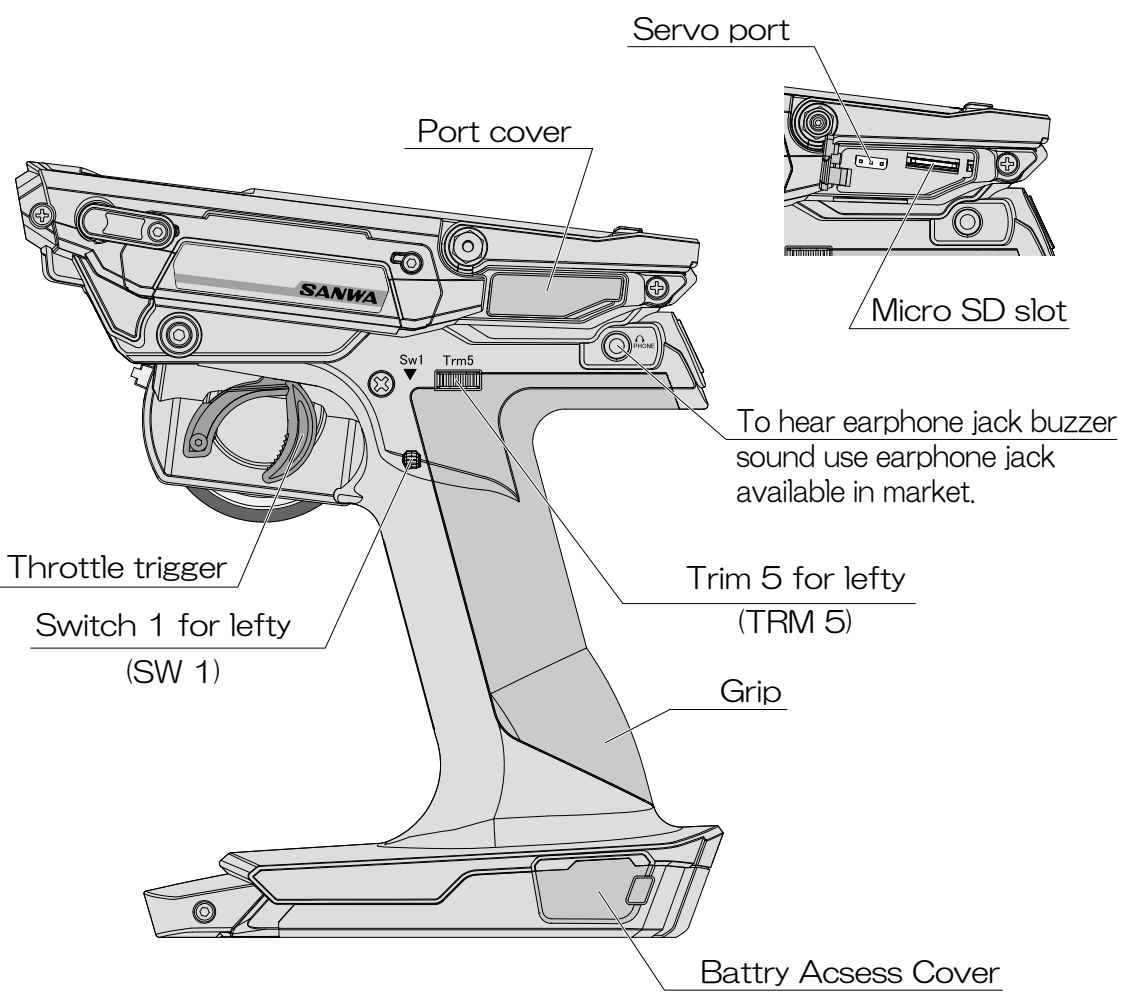

How to use each feature

Operation of TouchPad

● Setting, calling can be easily done by the gesture operation of touchpad.

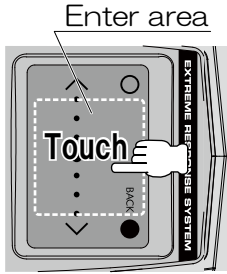
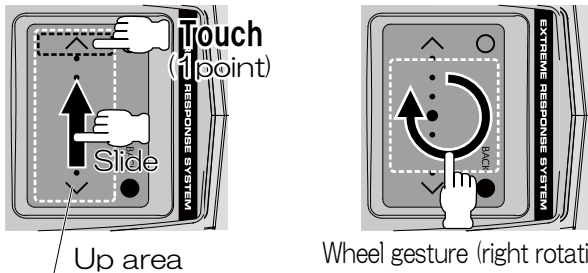
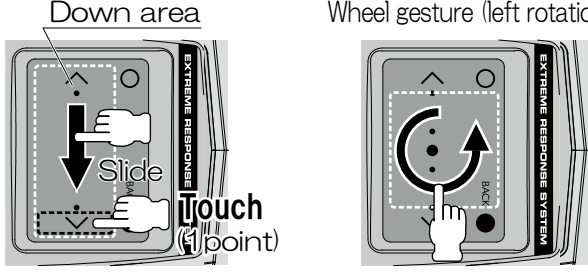
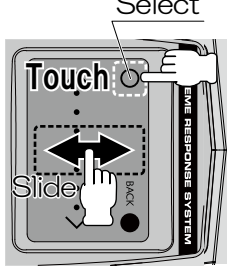
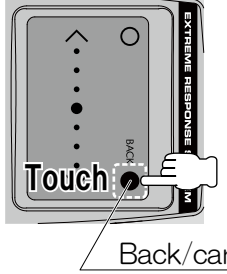
Gesture operation	Name	Operation
	Enter	<ul style="list-style-type: none"> ● Perform enter operation by touching such that enter area is lightly tapped by the fingertip. ● Move from the top screen to setting screen. <ul style="list-style-type: none"> • Select function and items to be set. • The set value returns to an initial value by long press. ☆ [Trim 4] down operation in DIAL OPERATION MODE
	Up	<ul style="list-style-type: none"> ● Perform up operation by sliding up the area by finger. ● The set value increases by 1 point each by touching such that black framed 1-point area is tapped. ○ The set value increases by wheel (right rotation) gesture during changing the set value. <ul style="list-style-type: none"> • Cursor moves to the upward direction. • The set value increases. ☆ [DIAL] operation in DIAL OPERATION MODE
	Down	<ul style="list-style-type: none"> ● Perform down operation by sliding down area by finger. ● The set value decreases by 1 point each by touching such that black framed 1-point area is tapped. ○ The set value decreases by wheel (left rotation) gesture during changing the set value. <ul style="list-style-type: none"> • Cursor moves to the downward direction. • The set value decreases. ☆ [DIAL] operation in DIAL OPERATION MODE
	Select	<ul style="list-style-type: none"> ● Perform select operation of channel or function by touching such that select area is lightly tapped by the fingertip. ※ The cursor can be moved to left or right by quickly sliding the black framed part to left or right. • Select channel or function. • The set value increases. ※ Change the operation position of select and back / cancel by setting to left (left-handedness). ☆ [SW2] operation in DIAL OPERATION MODE
	Back/cancel	<ul style="list-style-type: none"> ● Perform back/cancel the operation by touching such that the back / cancel area is lightly tapped by the fingertip. • Returns to the previous state. • Cancels setting. ※ Change the operation position of select and back / cancel by setting to left (left-handedness). ☆ [Trim 4] up operation in DIAL OPERATION MODE

How to use each feature

How to use each feature

Display Panel

- Each of the functions of M17S can be directly selected by touchpad operation.
- Functions of each channel can be separately set.
- Upon switching the power switch ON, top screen appears after boot screen display (when the setting of the boot is DEMO).

In case of changing various settings, operate touchpad and select menu.

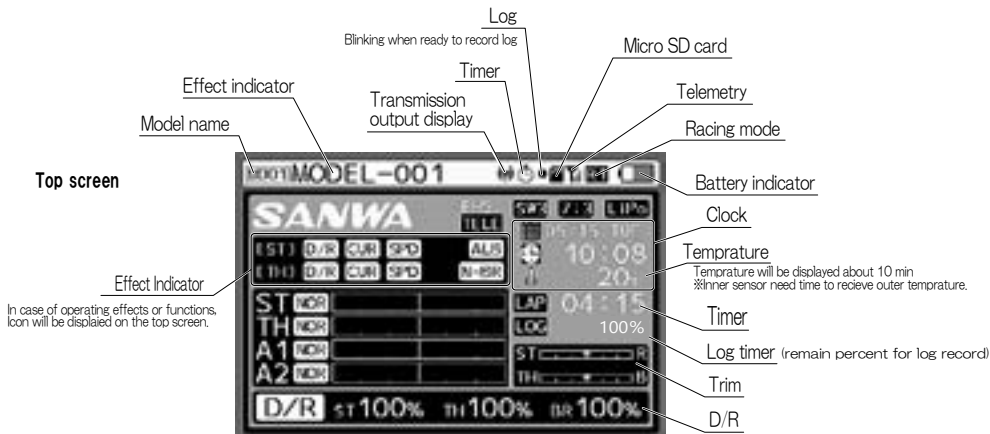

Top screen telemetry screen toggle upon performing up / down operation by touch pad.

Telemetry screen

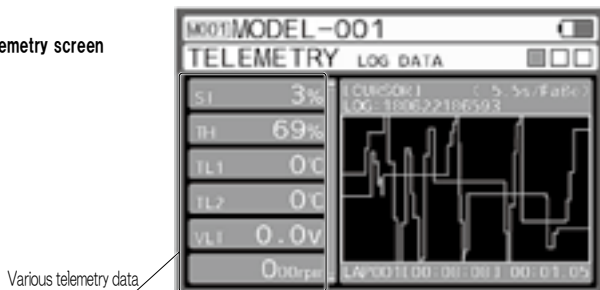

Combined with FH5 receiver with Super Vortex Gen2 PRO, SV-D2 and turned on telemetry function, transmitter can display the data

Menu window

- Select menu. (Screen example)
- ※Enter operation from top screen

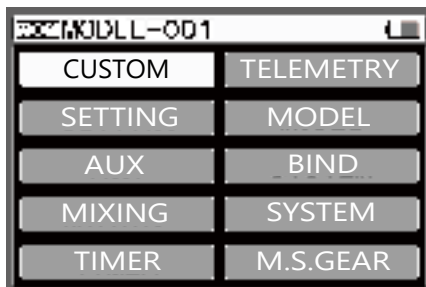

Power Supply Forget Alarm

- In M17S, if steering wheel, throttle trigger or various switches are not operated for 10 minutes, “No Operation” is displayed based on warning alarm and turning off of LED light. Warning is cancelled by operating steering wheel, throttle trigger or various switches. Switch OFF the power switch if not in use.
- ※ Setting can be changed by SETUP of SYSTEM. (P.97)



How to use each feature

Menu Structure

- Setting of functions, calling of model memory can be easily done by using respective keys.
- Menu consists of a menu of setting, AUX, model, timer, telemetry, system and it contains functions relating to respective menus.

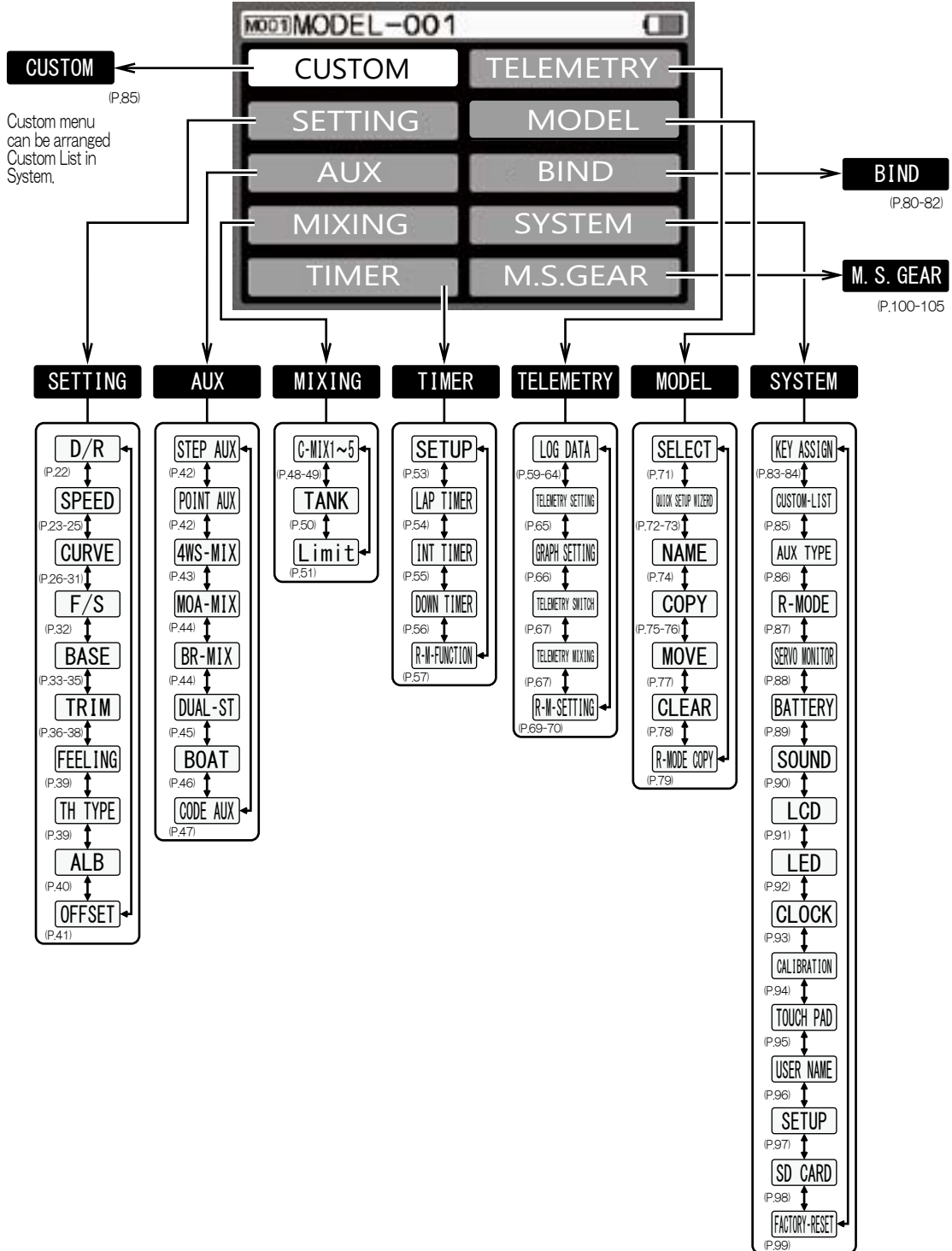

How to use each feature

How to use each feature

Launcher

● M17S is provided with a function of starting launcher (shortcut menu) by performing key operation simultaneously at the time of operating power switch.

Launcher function starts upon switching ON the power switch while pressing [SW 2].

The launcher is provided with [Model Select] and [RX Mode].

Model select is the function by which running model can be immediately selected.

RX mode can set various setting without radio wave output.

Model Select

● Direct Model Select

1) Turn the power switch on while pressing SW2.
Select direct model select from LAUNCHER.

2) Selection of model

Select model to be called by the select function.

○ Setting range M001 ~ M250

3) Upon moving the cursor to the model to be called and performing enter operation, the message is displayed on the screen.
Select the model while it is being displayed.

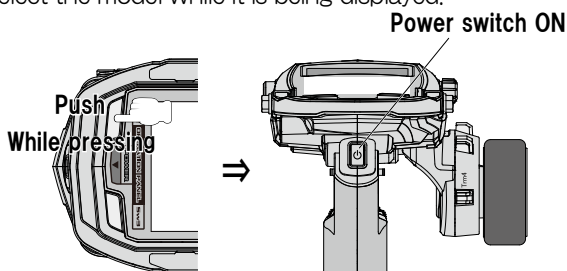

LAUNCHER screen

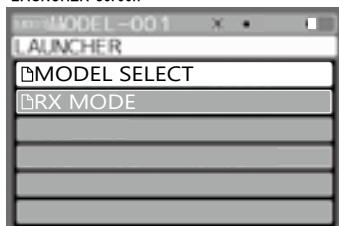

①DIRECT MODEL Screen

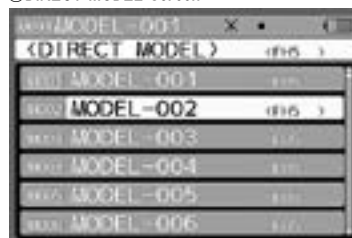

ENTER ↓ ↑ BACK

②Check screen

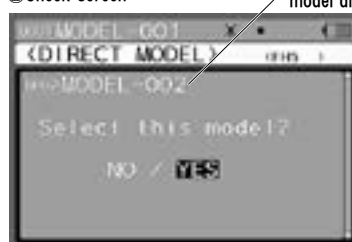

Change destination model display

•NO →Back to ①
•YES→Change model, to TOP

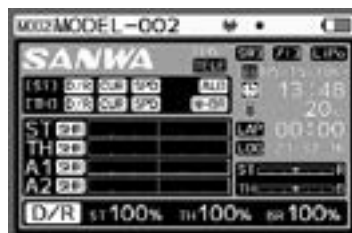

RX MODE

● RX MODE

Turn the power switch on while pressing SW2.

Select RX MODE from LAUNCHER.

RX mode can set various setting without radio wave output.

Power switch ON

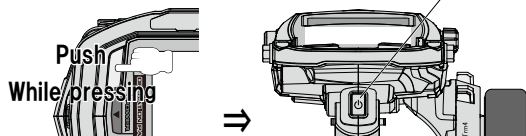

LAUNCHER screen

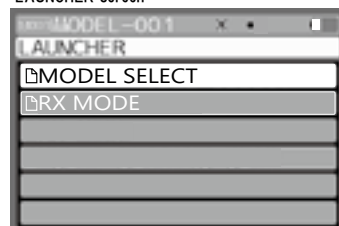

* Please refer how to set RX Mode (P.69-70).

* RX mode will be finished by turning off the transmitter.

How to use each feature

Dual Rate [D/R]

SETTING

- You can adjust steering angle when operating the steering wheel and throttle trigger to their peak. To correspond to the RC car or road condition, adjust the steering angle as you operate.
- ※ You can adjust steering for both right and left at the same time and throttle high and brake sides. You can also adjust the brake side more precisely than adjusting with EPA.
- Don't increase the setting rate of dual rates (D/R) from the condition in which the linkage locks by operating the steering wheel and throttle trigger.
- You can also adjust more precisely by adjusting dual rates of the throttle side.
- ※ When AUX1/AUX2 is set to CODE10, setting change of D/R will not be reflected on them.

1) Determine the Enter operation and select the [SETTING] with the touch pad.

2) Select features [ST/TH (H, L)/AUX1/AUX2] to adjust with the Select key.

3) Adjust the values of DUAL RATE by multi-selector. The text is in red color when up/down selection is available, and blue color when wheel selection is available.

4) During operation, the steering dual rates can be adjusted with Trim 3, brake dual rates can be adjusted with Trim 4. It's possible to assign other features to Trim 3 and Trim 5 with the key assign trim feature (P.84).

※ When cancelling a selected feature, operate the Back button.

- Setting range: ST/TH-H/AUX1/AUX2 : 0%~100%
TH-L : 0%~120%
- Default: ST/TH/AUX1/AUX2 : 100%

Trim 5
(TRM 5)

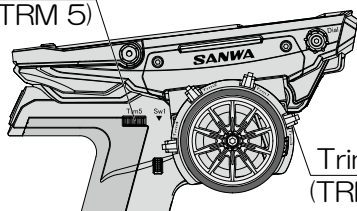

Trim 3
(TRM 3)

※ Make sure that the servos do not lock to make clicking sound note!

(Note) Same for throttle.

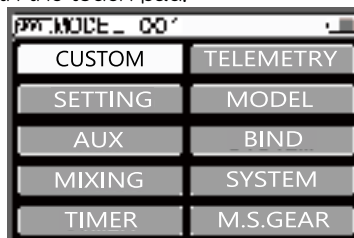
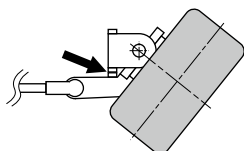

ENTER ↓ ↑ BACK

Dual rate
Setting screen

Select channel by select operation



ENTER ↓ ↑ BACK

Steering dual rate setting screen



Invert



Note

- If the linkage is locked for a long period, it can cause the servo motor breakage.

Supplement

- Adjust the end point of the steering/throttle linkage before adjusting dual rates (P. 33).

How to use each feature

SPEED

SETTING

● Feature to control the speed of the servos used for steering/ throttle. By setting, the RC car is not affected even when doing sudden operation. Smooth cornering is possible at the steering side for stable exist from the corner and by smooth throttle work which save power at the throttle side.

※ When the AUX type is set to [CODE10], adjustment of the speed feature of the AUX channel does not have any effect.

※ In case of setting the speed of the AUX channel, use steering/ throttle as a reference.

Steering Speed

● Feature to delay the speed of the steering servos against the steering operation. The speed at the time of turning the steering (forward) and the speed at the time of returning the steering (return) can be set individually. Speed Feature is not worked in the delay steering operation by default.

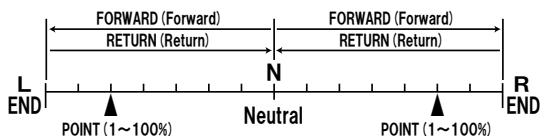

※ Whether the function of speed operates on the inner side (IN) or outer side (OUT) point (POINT) can be set by doing the setting of IN / OUT.

1) Select [SPEED] by touchpad and decide by enter operation.

Select [ST (Steering)] by the SELECT operation.

2) Forward Side Setting (FORWARD)

Select [FORWARD] and adjust the setting value by the touch pad.

※ Please do the back operation in case of cancelling the selected Feature.

○ Setting Range 0 ~ 100

○ Default Value 0

3) Return Side Setting

Select [RETURN] and adjust the setting value by the touch pad.

○ Setting Range 0 ~ - 100

○ Initial Value 0

※ Do the adjustments during actual operation. In case of not using the feature, or when the setting value is not determined even after adjustment, set the setting value to 0% (linear).

4) Setting point (POINT)

Adjust set value by touchpad by selecting [POINT].

○ Setting range 1 ~ 100%

○ Initial value 100%

5) Setting of in / out (IN / OUT)

Set touchpad by selecting [IN / OUT].

Set [IN] in case of operating on the inner side then point and set [OUT] in case of operating on the outer side.

○ Setting range IN / OUT

○ Initial value IN

※ Adjust during the actual run. Set the set value to 0 % (linear) when not using the function or when the set value is not decided even after adjustment.

[ST] selection by select operation

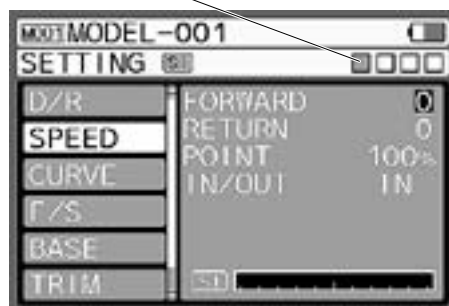

Supplement

- For driving the RC car, the steering operation consistent with the movement of the RC car is important. Excessive operation is restricted. Steering speed suppresses the unnecessary operation, and enables the smooth coming.
- The effect is further enhanced if the steering speed and steering curve are used in combination.

How to use each feature

SPEED

SETTING

Throttle Speed

- Feature to slow down the throttle servo performance speed and delay the response of the speed controller against the throttle operation. The speed at the time of turning the throttle (Forward) and the speed at the time of returning the throttle (return) can be set individually. Speed Feature does not work with the throttle operation delayed by setting. ※ Only high side setting can be done. Setting at the brake side is not possible.

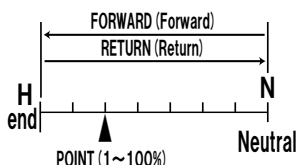

※ Whether the function of speed operates on the inner side (IN) or outer side (OUT) point (POINT) can be set by doing the setting of IN / OUT.

1) Select [SPEED] by touchpad and decide by enter operation. Select [TH (throttle)] by the SELECT Button.

2) Forward Side Setting (FORWARD)

Select [FORWARD] and adjust the setting value by the touch pad.

※ Please do the back operation in case of cancelling the selected feature.

○ Setting Range 0 ~ 100

○ Default Value 0

3) Return Side Setting

Select [RETURN] and adjust the setting value by the touch pad.

○ Setting Range 0 ~ 100

○ Default Value 0

※ Do the adjustments during actual operation. In case of not using the feature, or when the setting value is not determined even after adjustment, set the setting value to 0% (linear).

4) Setting of point (POINT)

Set POINT by the multi selector.

○ Setting range POINT H : 1 ~ 100%

○ Initial value POINT H : 50%

5) Setting in / out (IN / OUT)

Select [IN / OUT] and set touchpad.

Set [IN] in case of operating on inner side point and

set [OUT] in case of operating on the outer side.

○ Setting range IN / OUT

○ Initial value IN

※ Adjust during the actual run. Set the set value to 0 % (linear) when not using the function or when the set value is not decided even after adjustment.

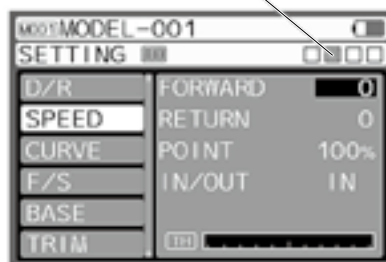

Supplement

- For driving the RC car, the steering operation consistent with the movement of the RC car is important. Excessive operation is restricted. Steering speed suppresses the unnecessary operation, and enables the smooth coming.
- The effect is further doubled if the steering speed and steering curve are used in combination.

How to use each feature

SPEED

SETTING

AUX1 / AUX2 • Speed [AUX-SPEED]

- Function that slows down speed of the servo with respect to the operation of AUX1 / AUX2. Speed of forward and return can be separately set. Speed function does not work in slow operation according to the setting.

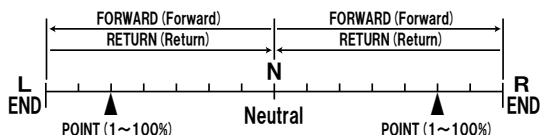

※ Whether the function of speed operates on the inner side (IN) or outer side (OUT) point (POINT) can be set by doing the setting of IN / OUT.

- 1) Select [SPEED] by touchpad and decide by enter operation and select [AUX1, AUX2] by the select operation.

- 2) Setting of forward side (FORWARD)

Select [FORWARD] and adjust the set value by touchpad.

※ Perform back operation in case of cancelling of the selected operation.

- Setting range 0 ~ 100
- Initial value 0

- 3) Setting of return side (RETURN)

Select [RETURN] and adjust the set value by touchpad.

- Setting range 0 ~ 100
- Initial value 0

- 4) Setting of point (POINT)

Select [POINT] and adjust the set value by touchpad.

- Setting range 1 ~ 100%
- Initial value 100%

- 5) Setting of IN / OUT (IN / OUT)

Set touchpad by selecting [IN / OUT].

Set [IN] in case of operating on inner side point and set [OUT] in case of operating on the outer side.

- Setting range IN / OUT
- Initial value IN

※ Adjust during the actual run. Set the set value to 0 % (linear) when not using the function or when the set value is not decided even after adjustment.

Channel selection by select operation

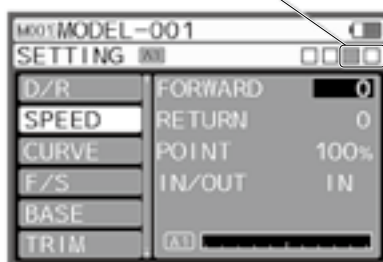

Supplement

- For driving of RC car, an operation that matches the motion of the RC car is important and over-operation is not permitted. AUX-speed suppresses unnecessary operation so that smooth operation can be realised.
- Efficiency doubles by combining AUX- speed and AUX- curve.

How to use each feature

CURVE

SETTING

- Function of making operation volume of servo variable with respect to the operation of the steering wheel, throttle trigger, AUX. It responds quickly when the set value is on plus (+) side whereas it responds mildly when the set value is on minus (-) side.
- Exponential (EXP) of curve operation and adjustable rate controller (ARC) of linear position, the operation of point curve (9 points) that operates by changing the set value for each point can be selected.
- ※ If the AUX type is set to [CODE], adjustment of the curve feature of the AUX channel does not affect the performance.
- ※ In case of adjustment of curve setting of the AUX channel, use the steering / throttle as a reference.
- Exponential (EXP)
- ※ For throttle, high side (H) / brake side (B) can be separately set.

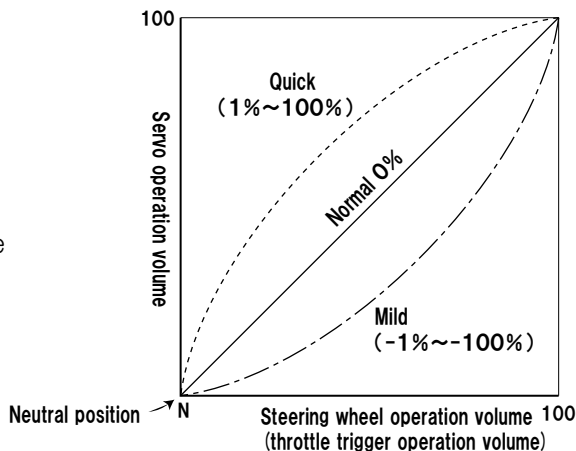

- Adjustable rate controller (ARC)
- Position at which operation is variable can be changed by adjusting the setting of POINT.
- ※ For throttle, high side (H) / brake (B) can be separately set.

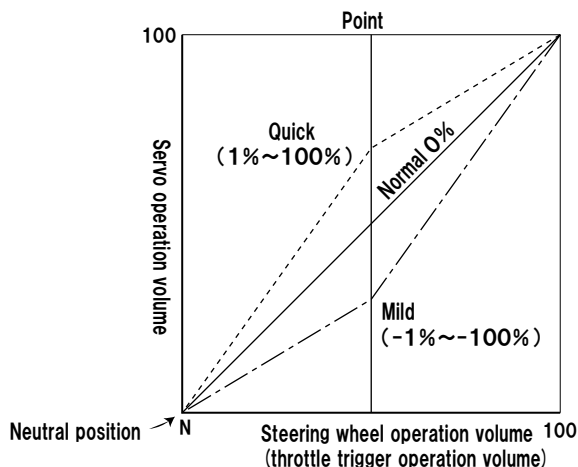

- Point curve (CRV)
- The operation can be made variable by adjusting the set value of the point (P1-P9).
- ※ For throttle, high side (H) / brake (B) can be separately set.

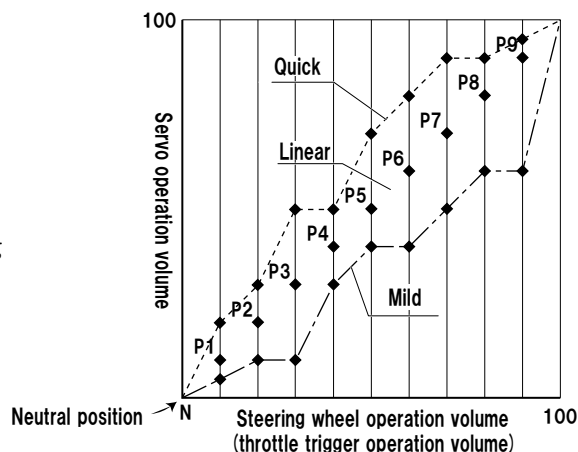

How to use each feature

How to use each feature

Steering Exponential [ST-EXP]

- Steering characteristics can vary from Mild ⇄ Linear ⇄ Quick. Generally, when the RC car senses the over-steer, the setting value is set to minus side, and when the RC car senses the under-steer, the numerical value is set to plus.
Steering exponential will do the L/R concurrent setting.

1) Select [CURVE] by touchpad and decide by enter operation.
Select ST by the SELECT Button, and set CURVE TYPE of ST to [EXP] by the touch pad.

2) Adjust the setting value by the touch pad

- Setting Range - 100% ~ 100%
- Default Value 0%

3) TWEAK Setting

- Setting Range - 100% ~ 100%
- Default Range 0

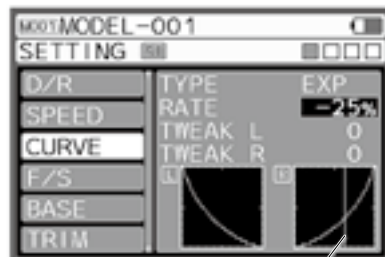

Steering operation position

- ※ Please do the back operation in case of cancelling the selected Feature.

Throttle/ Exponential [TH-EXP]

- You can change the throttle characteristics from Mild ⇄ linear ⇄ Quick. In general, when operating on a slippery road or if you find overpowering, change the setting value to the minus side and when operating on a high grip road, or if you find lack of power in the power unit, change the setting value to the plus side.

You can set the High side/ brake side separately.

- ※ Selection of High side/ brake side can be done by trigger operation.

1) Select [CURVE] by touchpad and decide by enter operation
Select TH with Select Button and select CURVE TYPE of TH to "EXP" with the touch pad.

2) Adjust the setting value with the touch pad.

- Setting range: -100% ~ 100%
- Default: 0%

Select H / B by trigger operation

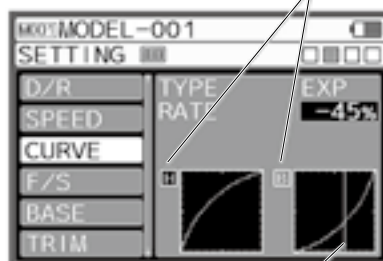

Throttle operation position

How to use each feature

CURVE

SETTING

AUX1/ Exponential [AUX1-EXP]

● You can change the operation feature of AUX1 from Mild ⇔ Linear ⇔ Quick.
You can set the High side and the Low side separately

※ When setting AUX1 to [CODE10] AUX TYPE, changing the setting does not affect the performance.

1) Select [CURVE] by touchpad and decide by enter operation
Select AUX1 with the Select button and set CURVE TYPE of AUX1 to [EXP] with the touch pad.

2) Adjust the setting value with the touch pad.

- Setting range: -100% ~ 100%
- Default: 0%

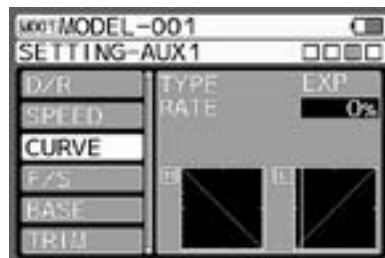

AUX2/ Exponential [AUX2-EXP]

● You can change the operation feature of AUX2 from Mild ⇔ Linear ⇔ Quick.
You can set the High side/ Low side separately.

※ When setting AUX2 to [CODE10] in AUX TYPE, changing the setting does not affect the performance.

1) Select [CURVE] by touchpad and decide by enter operation
Select AUX2 with the Select button and set CURVE TYPE of AUX2 to [EXP] with the touch pad.

2) Adjust the setting value with the touch pad.

- Setting range: -100% ~ 100%
- Default: 0%

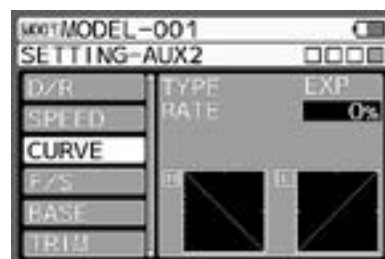

How to use each feature

Steering Adjustable Rate Control [ST-ARC]

● You can change the steering feature from Mild to Linear and to Quick. In general, if you find your RC car oversteering, change the setting to the minus side and if you find understeering, change to the plus side. Steering Adjustable Rate Control is the simultaneous setting for L/R.

1) Select [CURVE] by touchpad and decide by enter operation.
Select ST with the Select button and set CURVE TYPE of ST to [ARC] with the touchpad.

2) Setting Rate [RATE]
Select [RATE] with the touchpad and adjust the setting value.

- Setting range – 100% ~ 100%
- Default 0%

3) Setting Point (POINT)
Select [POINT] with the touchpad and adjust the setting value.

- Setting range 1% ~ 99%
- Default 50%

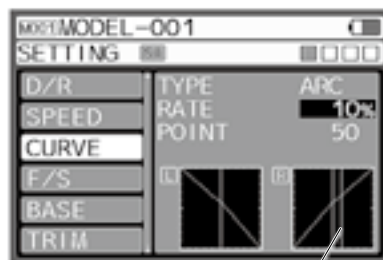

Steering operation position

※ When cancelling a selected feature, use the Back button.

Throttle Adjustable Rate Control [TH-ARC]

● You can change the throttle feature from Mild to Linear and to Quick. In general, when operating on a slippery road or if you find over powering, change the setting to the minus side and when operating on a high grip road or if you find lack of power in the power unit, change to plus side. You can set the High side and the brake side separately.

※ Selection of High side and the brake side is done by trigger operation.

1) Select [CURVE] by touchpad and decide by enter operation. Select TH with Select button and set CURVE TYPE of TH to [ARC] with the touchpad.

2) Setting Rate [RATE]
Select [RATE] with the touchpad and adjust the setting value.

- Setting range – 100% ~ 100%
- Default 0%

3) Setting Point (POINT)
Select [POINT] with the touchpad and adjust the setting value

- Setting range 1% ~ 99%
- Default 50%

Select H / B by trigger operation

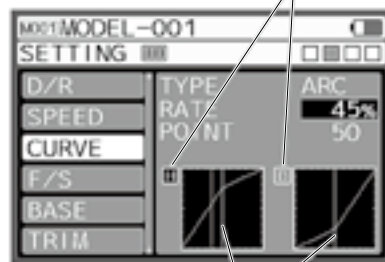

Point setting position

※ When cancelling a selected feature, use the Back button.

How to use each feature

CURVE

SETTING

AUX1 Adjustable Rate Control [AUX1-ARC]

● You can change the AUX1 performance feature from Mild to Linear and to Quick.

You can set the High side and low side separately.

※ When setting AUX1 to "CODE10" in AUX TYPE, changing the setting does not affect the performance.

1) Select [CURVE] by touchpad and decide by enter operation.

Select AUX1 with the Select button and set CURVE TYPE of AUX1 to [ARC] with the touchpad.

2) Setting Rate [RATE]

Select [RATE] with the touchpad and adjust the setting value.

○ Setting range -100% ~ 100%

○ Default 0%

3) Setting Point (POINT)

Select [POINT] with the touchpad and adjust the setting value.

○ Setting range -1% ~ 99%

○ Default 50%

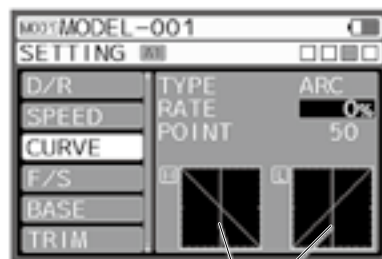

Point setting position

※ When cancelling a selected feature, use the Back button.

AUX2 Adjustable Rate Control [AUX2-ARC]

● You can change the operation feature of AUX2 from Mild to Linear and to Quick.

You can set the High side and the Low side separately.

※ When setting AUX1 to [CODE10] in AUX TYPE, changing the setting does not affect the performance.

1) Select [CURVE] by touchpad and decide by enter operation.

Select AUX2 with the Select button and set CURVE TYPE of AUX2 to [ARC] with the touchpad.

2) Setting Rate [RATE]

Select [RATE] with the touchpad and adjust the setting value.

○ Setting range -100% ~ 100%

○ Default 0%

3) Setting Point (POINT)

Select [POINT] with the touchpad and adjust the setting value.

○ Setting range -1% ~ 99%

○ Default 50%

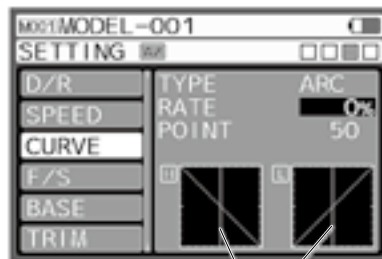

Point setting position

※ When cancelling a selected feature, use the Back button.

How to use each feature

CRV, Point Curve [ST / TH / AUX1 / AUX2 – CRV]

● Function of setting 9 points from controller such as steering, throttle, AUX to full throttle and making the operation variable by adjusting the set value for each point. For throttle, high side (H) / brake side (B) can be set separately.

1) Select < CURVE > by select operation. Decide by enter operation.

2) Select [CRV] by TYPE.

○ Setting range EXP/ARC/CRV

3) Select channel to be set by the select operation.

○ Setting range ST / TH / AUX1 / AUX2

4) Adjust the set value of each point of CRV by touchpad.

○ Setting range P1 ~ P9 : 0 ~ 100%

○ Initial value
P1 : 10%
P2 : 20%
P3 : 30%
P4 : 40%
P5 : 50%
P6 : 60%
P7 : 70%
P8 : 80%
P9 : 90%

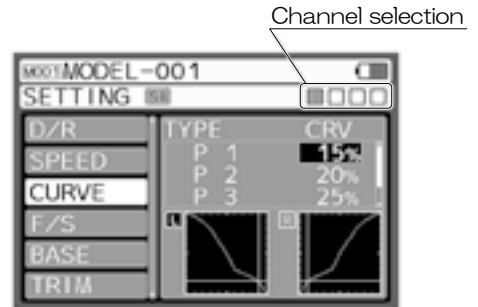

How to use each feature

Fail Safe [F/S]

SETTING

● Fail Safe Operation is a feature to keep the servo in a predetermined position for each channel in the event that the receiver cannot receive a power from the transmitter. A feature to keep the servos in a predetermined position for the servo of the throttle channel (2ch) in the event that the battery voltage on the receiver side of an engine RC car goes below the set voltage is Battery Fail Safe Operation.

● Fail Safe cannot set when setting OFF or HOLD.

* Please do not use when drive Electric RC car.

1) Select [F/S] with the touchpad and select a channel (ST/AUX1/AUX2) to set fail safe with the Select operation.

2) Enter the set channel and operate the touchpad and thereby the failsafe mode setting changes in the order of FREE → FS → HOLD.

○ Setting range FREE/FS(L150% ~ R150%, H150% ~ B150%)/HOLD

○ Default FREE

* Servo direction in Fail Safe setting is depends on REV setting in Base menu (P.40).

※ About each mode

FREE (Free Mode) When the receiver cannot receive the power from the transmitter, the signal output to the servo stops and the servo will be free.

FS (Fail Safe Mode) When the receiver cannot receive the power from the transmitter, the servo will be held in the set position.

HOLD (Hold Mode) The last position before the power from the transmitter to the receiver is lost, will be held.

• When the power is received from the transmitter again, each mode of FREE/HOLD/FS is automatically released.

3) Setting the Fail Safe (FS)

Move to the position where the Fail Safe Operation is used. When the position is determined, long press the touchpad to set the position when the Fail Safe Operation works.

※ For safety reason, we recommend setting the throttle channel on the brake side when setting the Fail Safe.

4) Setting the battery Fail Safe Operation

After setting the throttle channel position, move the cursor to [B-F/S] to set the voltage.

○ Setting range For FH5/FH4 : OFF, 3.5v ~ 7.4v

※ The Battery Fail Safe Operation is a feature to activate Fail Safe Operation when the receiver battery voltage rises up to the set voltage on a Nitro car. Do not use the Battery Fail Safe feature on electric RC cars.

5) Checking the Fail Safe Function

Turn off the power of the transmitter while the Fail Safe Operation is set and check if the servo moves to the position where the Fail Safe Operation is set.

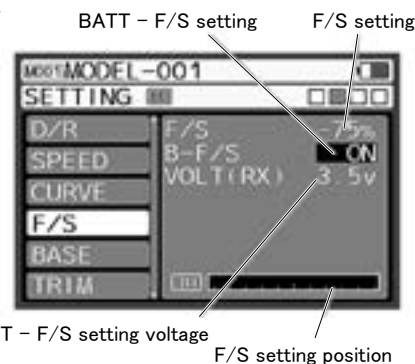
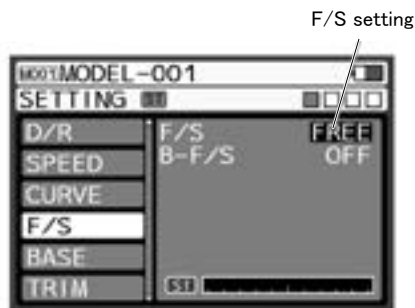

How to use each feature

Important

● About the Fail Safe Operation

When the Fail Safe feature is on, check the setting of the Fail Safe before operating. Do not change the setting of the Fail Safe during operation.

How to use each feature

BASE

SETTING

- Base [BASE] contains basic features such as Reverse that determines the direction of the servo of each channel and the speed controller according to a specific RC car, the Sub Trim that adjusts the neutral position and the End Point Adjustment [EPA] that sets the operating range into one feature (Base) to allow you to make a setting all at once.

End Point Adjustment [EPA]

BASE

- You can adjust the left and right operating range of the steering servo when operating the steering wheel/throttle trigger and operating range of the high side and brake side of throttle servo, and the servo operating range of AUX1, AUX2 (3ch, 4ch)

Steering End Point Adjustment [ST-EPA]

- The right and left cornering radius can be different due to the linkage or suspension and difference in tire diameter. In case of this, this feature adjusts the servo operating range at right and left side so that the right and left cornering radius can be the same.

- 1) Before adjusting the Steering End Point Adjustment (ST-EPA), make a neutral adjustment of the servo. (P.35)
 - Neutral adjustment is to align the center position with Sub Trim by switching ON the power and installing the servo horn in the approximate center position.
- 2) Select either of [EPA-L/EPA-R] with the touch pad and determine with enter.
- 3) Select the operating range with the touch pad
 - ※ When the cursor is on either of EPA-L/EPA-R, it is also possible to move the cursor by steering operation.

- Setting range: L/R 0~150%
- Default: L/R 100%

※Make sure the servos do not lock and make clicking sound.

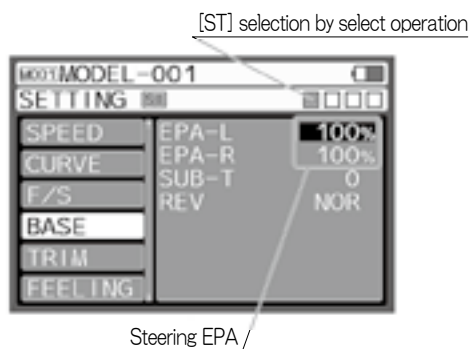
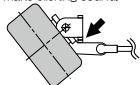

- Note** ● If the linkage is locked for a long period, it can cause the servo breakage.

Throttle End Point Adjustment [TH-EPA]

- It adjusts the high point of FET Speed Controller, Brake Point, carburettor of engine cars and the brake operating range.

- 1) For an engine car, make a neutral adjustment of the servo before adjusting the Throttle End Point Adjustment (TH-EPA). (P.35)
 - Neutral adjustment is to align the center position with Sub Trim by switching ON the power and installing the servo horn in the approximate center position.

- 2) Select [TH/Throttle] with the Select button.
- 3) Select either of [EPA-H/EPA-B] with the touch pad and determine with the Enter
- 4) Adjust the operating range with the touch pad.
 - When adjusting FET Speed Controller, normally set both the high side and the brake side to 100% and set neutral, high point and brake point on the FET Speed Controller side (the Setting method is different depending on the FET Speed Controller).
 - ※ When the cursor is on either of EPA-H/EPA-B, it is also possible to move the cursor by trigger operation.

- Setting range: H/B 0~150%
- Default: H/B 100%

※Make sure the servos do not lock and make clicking sound

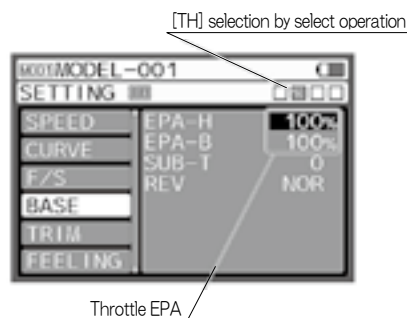

- Note** ● When EPA setting value is too large on the fully open side of the carburetor and the brake side for throttle linkage, the servo is locked, and it can cause the motor malfunction and runaway.

How to use each feature

AUX1 End Point Adjustment

- You can use AUX1 for functions of accessories and adjust the maximum steering angle (operating range) with EPA. Since you can set H (High) /L (Low) separately, the precise adjustment is possible.
- ※ When setting AUX1 to [CODE 10] in AUX TYPE, the operation will not be reflected even by adjusting EPA.

- 1) Before adjusting AUX1 End Point Adjustment (AUX1-EPA), make a neutral adjustment of the servo (P.35).
 - Neutral adjustment is to align the center position with Sub Trim by turning the power on and installing the servo horn in the approximate center position.

- 2) Select [AUX1] with the Select operation, select either of [EPA-H/ EPA-L] with the touchpad and determine with the Enter.

- 3) Adjust the operating range with the touchpad.

○ Setting range: H/L 0~ 150%

○ Default: H/L 100%

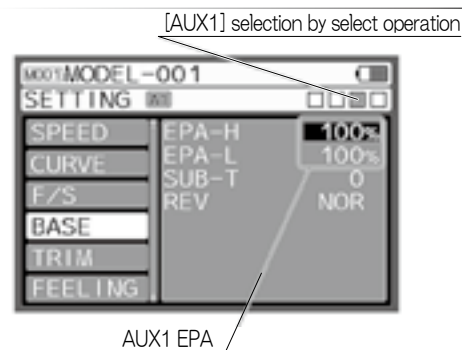

AUX2 End Point Adjustment

- You can use AUX2 for functions of accessories and adjust the maximum steering angle (operating range) with EPA. Since you can set H (High) /L (Low) separately, the precise adjustment is possible.
- ※ When setting AUX2 to [CODE 10] in AUX TYPE, the operation will not be reflected even by adjusting EPA.

- 1) Before adjusting AUX2 End Point Adjustment (AUX2-EPA), make a neutral adjustment of the servo (P.35).
 - Neutral adjustment is to align the center position with Sub Trim by turning the power on and installing the servo horn in the approximate center position.

- 2) Select [AUX2] with the Select button, select either of [EPA-H/ EPA-L] with the touchpad and determine with the Enter.

- 3) Adjust the operating range with the touchpad.

○ Setting range: H/L 0~ 150%

○ Default: H/L 100%

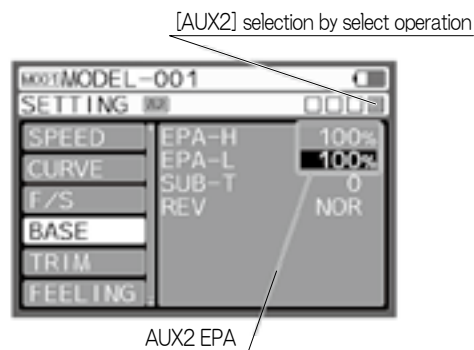

How to use each feature

Reverse [REV]

BASE

- This is used when the operation and the movement of the servo are reversed for Steering / Throttle / AUX 1 / AUX 2.
- 1) Select [BASE] with the touch pad and select a channel to set (ST / TH / AUX 1 / AUX 2) by the select operation.
- 2) If you operate the touchpad by enter operation with the channels to be set, the reverse setting will be changed.
- ※ When cancelling a selected feature, use the back operation.

- Setting range NOR/REV
- Default NOR

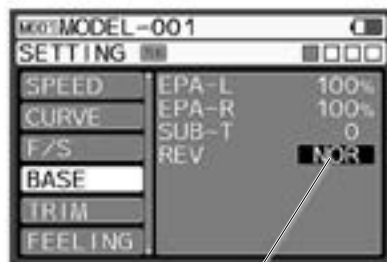

REV setting

Sub Trim [SUB-T]

BASE

- Using the Sub Trim feature, correct the neutral (center) of Steering / Throttle / AUX 1 / AUX 2 so that trim can be used in the center position. When installing a servo on to an RC car, center the servo with Sub Trim first before adjusting End Point Adjustment.
- 1) Before starting, set each main trim at the center (0) before use.

- 2) Select [SUB - T] with the touchpad and select a channel (ST/TH/AUX1/AUX2) to adjust Sub Trim by the select operation.
- 3) Determine by Enter operation in the channel to be set.
- 4) Install the servo arm (servo saver arm) at the place nearest to the center position.
- ※ For installation position of the servo arm, follow the instruction manual of the RC car side.

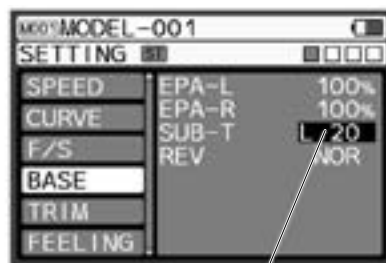

SUB - T setting

- 5) Use the touchpad to adjust the center.

- Setting Range L150 ~ R150(ST), H150 ~ B150(TH), H150 ~ L150(AUX1, AUX2)
- Default 0

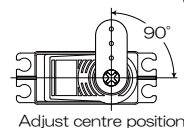
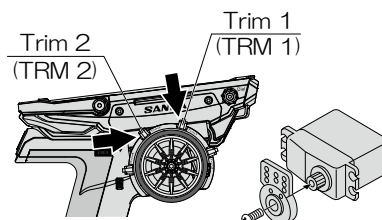

Note

- When installing the servo arm on the servo, fix the servo arm as close to the center as possible and center it with Sub Trim. If Sub Trim and the transmitter main trim are off to one side, it causes dead band (the area where the servo does not move) to the steering wheel and the throttle trigger.

Important

- About Trim and Sub trim

Trim is a feature for adjusting the neutral (center) position of the servo. When your car does not run straight after installing the steering servo onto the car body, Trim adjusts the main trim of the steering. Also, the neutral position of the carburetor in the engine RC car needs neutral adjustment of the throttle servo along with linkage adjustment after installing the servo. Neutral position adjustment is necessary not only after installing the servo but for changes that happen during running such as tire wear and chassis twist. M17 Trim features two types of Trim including Center Trim that adjusts only the neutral position without changing the end of the operating angle and Parallel Trim that moves the end of the operating angle and the neutral position simultaneously. Sub Trim that adjusts the neutral (center) position before fixing the servo horn is the parallel trim and the main trim is Center Trim.

- Center trim (Main Trim)
Even if you move the neutral position with Trim, the end of the operation angle does not move.



- Parallel trim (Sub Trim)
When you move the neutral position with Trim, the end of the operation angle also moves. When Sub Trim is adjusted after linkage is completed, readjustment of End Point Adjustment (EPA) will be necessary.

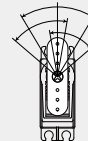

How to use each feature

TRIM

SETTING

- Trim can adjust the trim of each channel and set the trim action (centre/parallel).

TRIM

- Use the trim to correct the neutral (centre) of each channel (ST / TH / AUX 1 / AUX 2).
- In the initial setting, steering is set to trim 1 (TRM 1), and the throttle is set to trim 2 (TRM 2).

1) Select the channel (ST / TH / AUX 1 / AUX 2) for trim adjustment by SELECT operation.

Channel selection by select operation

2) Confirm with the ENTER operation n and adjust with the touchpad.

○ Setting Range ST : L100 ~ R100
 TH : H100 ~ B100
 AUX1 : H100 ~ L100
 AUX2 : H100 ~ L100

○ Initial Value ST : 0
 TH : 0
 AUX1 : 0
 AUX2 : 0

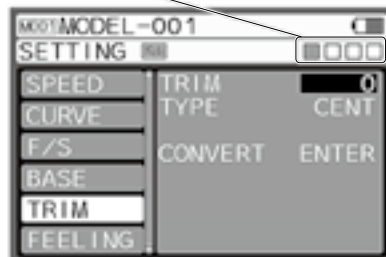

※ During operation, adjust the trim adjustment with TRM1 (ST), TRM2 (TH). The position of the trim lever can be changed with the key assignment trim function.

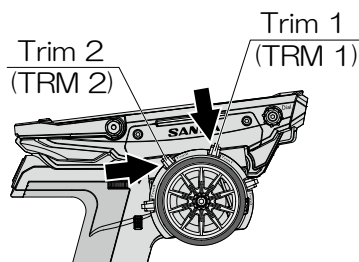

Important

- About TRIM

Trim is the function to adjust the neutral (centre) position of the servo. After installing the steering servo on the car body, adjust it with trim while it is running and do not go straight ahead. Adjustment of neutral position is necessary not only for servo installation but also for dealing with changes during running such as tire wear and tear and twisting of chassis.

- The sub trim adjusts the centre position when adjusting the linkage. (P.35)

How to use each feature

TRIM TYPE

- The trim operation of each channel can be set to centre trim (CENT) and parallel trim (PARA).
- In the initial setting, steering is set to Trim 1 (TRM 1), and the throttle is set to Trim 2 (TRM 2).

1) Select [TRIM] by touchpad and define by enter operation

Select the channel (ST / TH / AUX 1 / AUX) to be set with the SELECT operation.

2) Confirm with ENTER operation and adjust with the touch pad.

- Setting range CENT (centre trim) / PARA (parallel trim)
- Initial value CENT (centre trim)

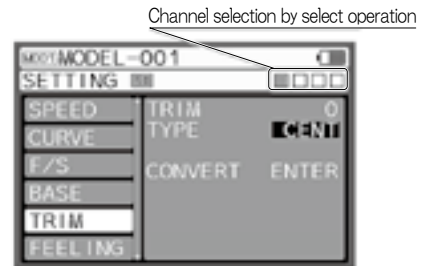

Important

- About centre trim and parallel trim

There are two kinds of trims: one is centre trim, which during trim operation adjusts only the neutral position while keeping the end of the motion angle intact and the other is parallel trim, which move end of motion angle and neutral position together during trim operation. The parallel trim is sub trim that adjusts the neutral (centre) position before confirming the sub horn and the main trim is the selection formula of centre trim and parallel trim. Please set according to the use.

○ Centre Trim

Even if you move the neutral position with trim, the end of the operating angle will not move.



○ Parallel Trim

When you move the neutral position with trim, the end of the operating angle also moves together. If the sub trim is adjusted after linkage is performed, it is necessary to readjust the end-point adjustment (EPA).

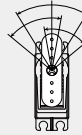

How to use each feature

CONVERT

● It converts the trim adjusted for each channel to sub trim and EPA and corrects trim to centre.

Depending on the setting, the conversion may not be possible.

1) Select [TRIM] by touchpad and define by enter operation.
 Select the channel (ST / TH / AUX 1 / AUX 2) to convert by the select operation.

2) After the channel to be set is decided, convert function is operated by ENTER operation.

3) As an example, if the conversion function is used when the steering trim is [L20] and the EPA is 100% each, it will be as the flow in the right figure. The trim becomes centre (0), the trim movement is converted to sub trim and EPA.

※ Convert can be set for each channel.

Channel selection by select operation

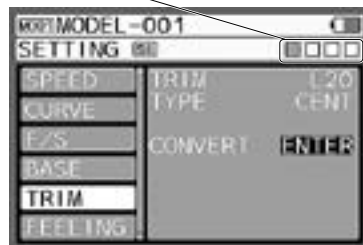

ENTER ↓ ↑ BACK



ENTER ↓ ↑ BACK

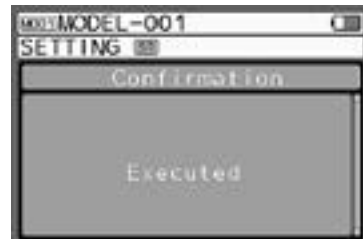

Conversion complete ↓



*After conversion, display will be back trim display.

How to use each feature

How to use each feature

FEELING

SETTING

● The Feeling function allows you to adjust the Response Time of the Steering and Throttle channels to fine-tune the sensitivity of these controls.

- 1) Select [FEELING] with the touchpad and confirm with the enter operation.
- 2) Select the channel (ST / TH) for setting FEELING by scrolling left or right, and confirm with the enter operation.
- 3) After selecting the channel to set up, press enter operation again, and adjust the setting by scrolling up or down.

- Setting Range ST : 25 ~ 1
 TH : 25 ~ 1
- Initial Value ST : 25
 TH : 25

- ※ Select 25 for the fastest response.
Adjust between 25 to 1 to fine tune the desired response feeling.
Select 1 will result in slowest response and rough operation.
- ※ You do not need to re-BIND even if you change the setting.
- ※ The Response Mode selected during BIND operation will not be affect by this function.
- ※ FEELING setting is only available for Steering and Throttle.

Channel selection by select operation

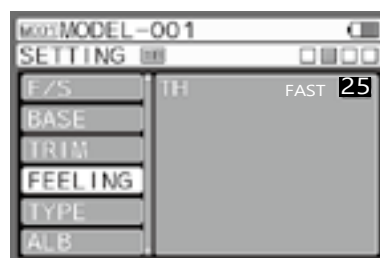
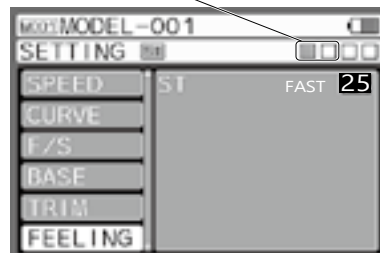

THROTTLE TYPE [TH TYPE]

SETTING

- By moving the neutral position of the throttle, you can set the operation ratio between the forward side and the brake (reverse) side to either 7:3 or 5:5.
- ※ Please set the throttle type which is suitable for your speed controller.

- 1) Select [TYPE] with the touchpad and confirm with enter.
※ TYPE is not displayed unless the throttle channel is selected.

- 2) Throttle type setting (TH TYPE)
Set the throttle type with the touchpad.

- Setting Range F 7 : B 3 / F 5 : B 5
- Initial Value F 7 : B 3

- ※ If you change the TH TYPE, a confirmation screen will pop up and a message will be displayed on the screen. Select YES to confirm your new setting.



ENTER ↓ ↑ BACK



How to use each feature

ANTI-LOCK BRAKE [ALB]

SETTING

- Anti-lock brakes make it possible to achieve stable braking on a low grip surface.
- Since the braking is stable, you can trace the cornering line as desired.

1) Select [ALB] by touchpad and define by enter operation.
 ※ ALB is not displayed unless the throttle channel is selected.

2) Setting of STROKE

Set the ALB stroke with the touchpad.

The stroke is the amount of brake reduction applied during the "OFF" time of ALB braking.

- Setting Range OFF, 0 ~ 100%
- Initial Value OFF ※ When OFF, ALB will not operate.

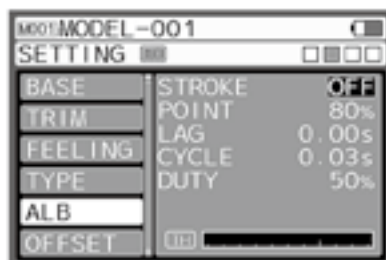

ENTER ↓ ↑ BACK

3) Setting of POINT

Set the ALB point with the touchpad.

Point is the starting brake point when ALB is activated.

- Setting Range 5% ~ 100%
- Initial Value 80%

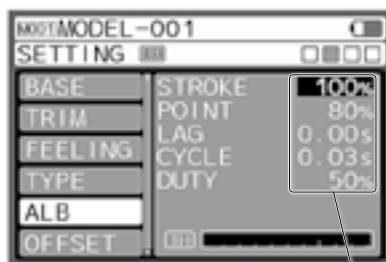

Set each parameter

4) Setting of LAG

Set ALB lag with the touchpad.

LAG is the time delay (in second) until ALB start to operate.

- Setting Range 0.00s ~ 1.00s
- Initial Value 0.00s

5) Setting of Cycle

Set the ALB cycle with the touchpad.

CYCLE is the period (in second) for each alternating cycle of ON / OFF braking during ALB.

- Setting Range 0.01s ~ 1.00s
- Initial Value 0.03s

6) Setting of DUTY

Set duty of ALB with the touch pad.

DUTY is the ratio of ON / OFF braking during ALB.

- Setting Range 20 ~ 100%
- Initial Value 50%

※ The function LED blinks during the anti-lock brake operation.

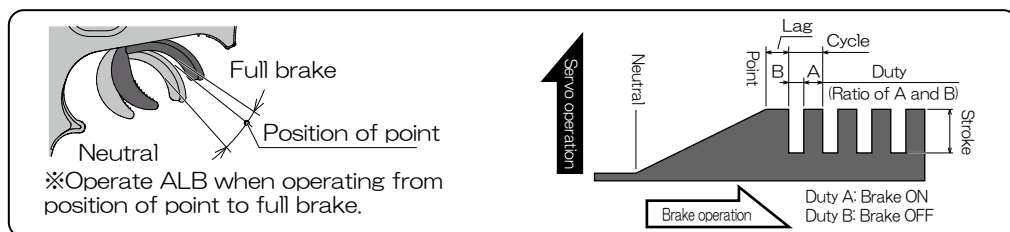

Supplement

- Adjust the brake such that the tire of the RC car does not lose the grip force (does not slide), so that the brake is strengthened and the anti-lock brake will work just before the tire locks and slides.
- If ALB is set by using the speed controller with the back of the electric RC car, the back operation may become impossible. To use back operation, please turn off ALB.

How to use each feature

OFFSET

SETTING

- The Throttle Offset function allows you to temporarily shift the Neutral Point of the Throttle to help in GP car's engine start up.
- The Neutral Point of the Throttle can be raised so that the engine does not stop during refueling of the car. [I-UP]
- The Neutral Point of the Throttle can be locked to a low position to stop the engine. For example, when trying shut down engine for GP boat. [TH CUT]
- The Neutral Point of the Throttle can be shifted to a low position to apply neutral brake (drag brake) for EP cars. [N-BR]
- The ON/OFF toggle of Throttle Offset function is not assigned to any switch or button by default. When using this function, please assign it in Key Assignment. (Page 83 - 84)

1) Select [OFFSET] with the touchpad and confirm with enter
 ※ OFFSET is not displayed unless the throttle channel is selected.

2) Offset setting
 set the offset function ON / OFF with the touch pad.

- Setting Range ON/OFF
- Initial Value OFF

3) Setting of TYPE
 Set the offset type with the touchpad.

- Setting Range I-UP (Idle Up) / N-BR (Neutral Brake) / TH CUT (Throttle Cut)
- Initial Value I-UP

4) Setting of POINT
 Set the offset point with the touchpad.

- Setting Range 0% ~ 100%
- Initial Value 0%

5) Setting of BEEP
 Set offset operation alarm (BEEP)

- Setting Range ON/OFF
- Initial Value ON

※ The function LED blinks during offset function operation.

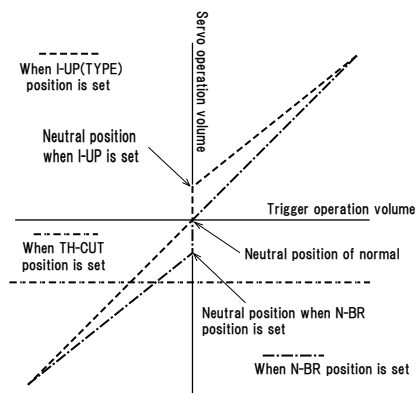

How to use each feature

AUX

- AUX is a function to set the operation of AUX 1, AUX 2 (3 ch, 4 ch). You can choose from STEP AUX (STEP), POINT AUX (POINT), 4WS (4 wheel steering: same phase, opposite phase), MOA (Front and rear drive), Brake mixing (BR-MIX), Dual Steering (Dual STEERING) and CODE AUX (CODE10).
- ※ Set the AUX TYPE by the system menu. Please set according to the application to use.

STEP AUX

AUX

- By setting the step AUX function, the motion amount can be set by the operation of the assigned trim or switch.
- During factory shipment, the AUX function is set to step AUX.

1) Select [AUX] with the touchpad and confirm with the enter operation.

2) STEP AUX setting (STEP AUX)

Set operation position for STEP AUX.

The step motion amount can be effected by MODE in AUX TYPE. Please adjust step motion amount by usage.

※ Step motion amount is 1/2/5/10/20/25/50/100, and can be set by MODE in AUX TYPE.

※ Step motion amount can be set by EPA (P.34).

※ Please use the function by assigning trim or dial by key assignment according to usage.

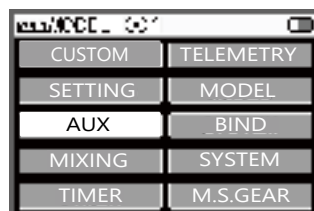

ENTER ↓ ↑ BACK



Adjust step motion amount by AUX TYPE

POINT AUX

AUX

- By setting POINT AUX, it is possible to move the servo to the point set by assigning the operation of AUX 1 / AUX 2 (3ch / 4 ch) to the switch or trim.

Since you can set the moved point with EPA (end-point adjustment), adjust the point position according to the usage.

※ The number of points will be 2 to 6 points and shall be set with MODE in AUX TYPE.

1) Select [AUX] with touch pad and confirm with ENTER operation.

2) Confirm the [CH] moved by the select operation of Point Aux Setting (POINT AUX) and set the motion point with the touchpad.

※ Please set to [POINT AUX] with [AUX TYPE] of [SYSTEM] according to usage.

※ Assign functions to dials and trims by key assignment or please operate with the touch pad.

※ If you assign Point AUX to Switch, it can be turn ON/OFF operation point (OFF position is neutral point).

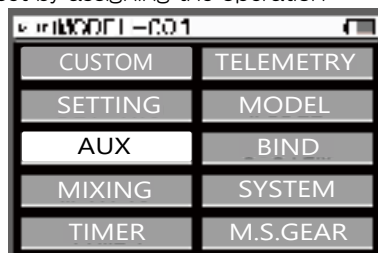

ENTER ↓ ↑ BACK

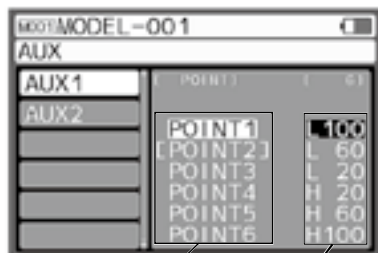

Select operation point

Select motion amount

How to use each feature

4 Wheel steering (4 wheel steering: same phase/opposite phase [4 WS])

AUX

● The operation of 4 wheel steering (4 wheel steering) is controlled by the operation of the assigned trim and switch.

1) Select [AUX] with touch pad and confirm with enter operation.

2) Motion mode setting

Set the 4WS motion mode with the touchpad.

Set the motion mode according to usage.

※ When using while running please assign the function of motion mode to dial, trim or switch.

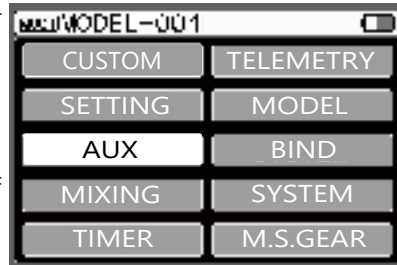

ENTER ↓ ↑ BACK

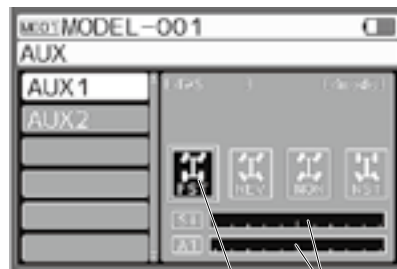

Servo monitor
Switch-over of operation mode

[Steering Operation Image]

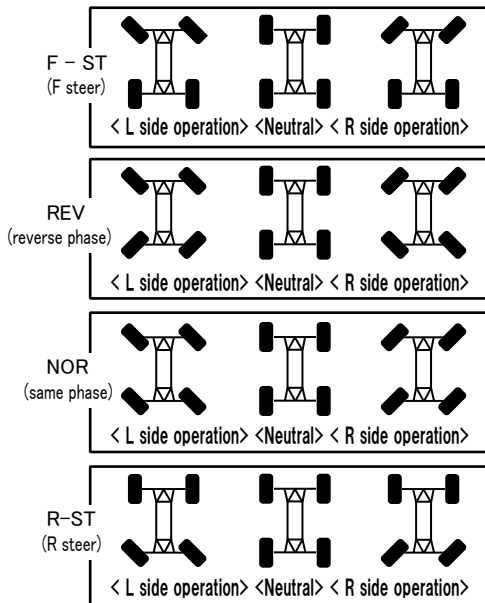

How to use each feature

MOTOR ON AXLE [MOA] (Front and rear drive)

AUX

● By setting motor on the axle (MOA), front rear drive ratio can be adjusted with front and rear 2 motor specification body.

1) Select [AUX] with the touchpad and confirm with the enter operation.

2) Motion Mode Setting

Set the MOA motion with the touchpad.

※ Set step setting for changing front and rear drive distribution with [MODE] of [AUX TYPE] of [SYSTEM].

※ When using, assign the function to trim, dial, or operate with the touch pad. (Key Assignment Page 83, 84)

※ Connect the speed controller that controls the rear motor to the channel (AUX 1 / AUX 2) where TYPE is set to MOA.

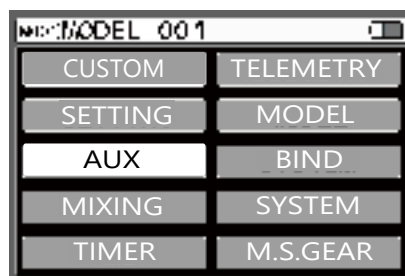

ENTER ↓ ↑ BACK

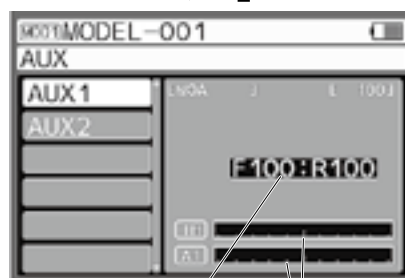

Front - rear driving ratio
Servo monitor

[MOA operation image]

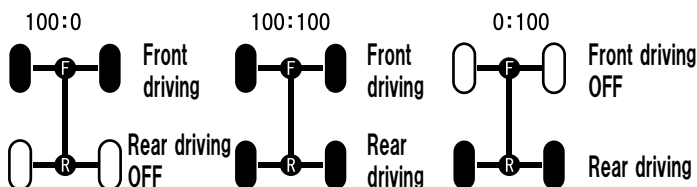

※ The front and rear driving ratio can be adjusted by changing the ratio.

Brake mixing [BR-MIX]

AUX

● It is a function that adjusts the operation timing when the brakes are operating when the front and rear brakes of 1/5 scale engine RC car are controlled by servo other than throttle servo.

1) Select [BR-MIX] using the touch pad and confirm it by Enter operation.

2) Setting brake delay (BR1-DELAY)

Set BR operation timing using the touchpad.

○ Setting range 0 to -100%

○ Initial value 0%

3) Brake 2 delay setting (BR2-DELAY)

Set BR2 operation timing using the touch pad.

○ Setting range 0 to -100%

○ Initial value 0%

※ Please set Brake mixing in [TYPE] of [AUX TYPE] in [SYSTEM].

BR1-DELAY is for AUX1. BR2-DELAY is for AUX2.

※ When using, assign the function to trim, dial, or operate with the touch pad.

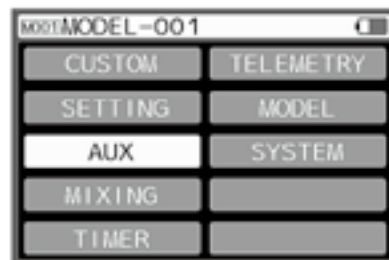

ENTER ↓ ↑ BACK

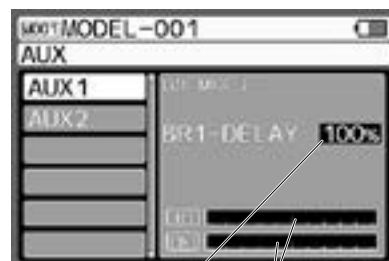

Displays brake operation
Setting of mixing rate

[Back to INDEX](#)

How to use each feature

Dual Steering [DUAL STEERING]

AUX [AUX]

- Operation volume of left and right can be separately adjusted by loading 2 steering servos.
- Smooth cornering can be realised by adjustment of Ackerman function.

1) Select [AUX] by touchpad and define by enter operation.

2) Setting of dual steering (DUAL ST)

Decide items to be set by select operation and set DUAL ST by the operation of the touchpad.

※ Set the left-right servo operation volume by EPA.
(Endpoint adjust P.33, 34)

3) Setting of Ackerman (ACKERMAN)

Set cornering characteristics by the setting of Ackerman.

※ Always do the adjustment of Ackerman after completing adjustment of left-right servo operation.

- Setting range +100 ~ 0 ~ -100
- Initial value 0

4) Setting of dual rate (DUAL RATE)

Adjust steering operation volume at the time of performing maximum steering operation.

- Setting range 0 ~ 100%
- Initial value 100%

5) Setting of steering L (ST - L)

Set the operation volume of steering left side.

- Setting range 0 ~ 100%
- Initial value 100%

6) Setting of steering R (ST - R)

Set the operation volume of steering right side.

- Setting range 0 ~ 100%
- Initial value 100%

7) Setting of centre (Centre) and toe (TOE)

Set centre and toe of the steering.

- Setting range Centre (CENTRE) +150 ~ 0 ~ -150%
- Toe (TOE) +150 ~ 0 ~ -150%
- Initial value Centre 0%
- Toe 0%

※ Do the adjustment of operation volume of left and right servo by EPA in SETTING BASE (endpoint adjust).

※ Please use the function by assigning trim or dial by key assignment according to usage.

If assigned Ackerman function to switch, it can turn ON/OFF Ackerman function.

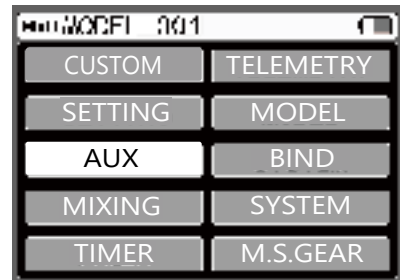

ENTER ↓ ↑ BACK

Setting of Ackerman

Setting of dual rate operation

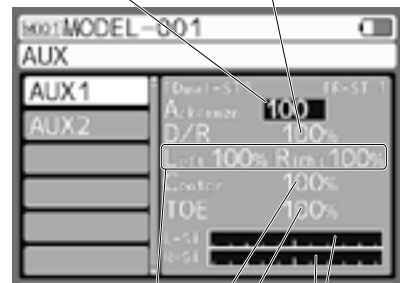

Setting of steering L / R

Setting of centre

Setting of toe

Displays steering operation

How to use each feature

Boat [BOAT]

AUX [AUX]

● Function of mixing from throttle to flap by setting boat AUX.

1) Select [AUX] by touchpad and define by enter operation.

2) Setting of the boat (BOAT)

Decide the function to be operated by select operation and set operation volume and mixing volume by the touchpad.

○ Setting range FLAP L100 ~ 0 ~ H100
Throttle → FLAP -100 ~ 0 ~ 100

○ Initial value FLAP 0
Throttle → FLAP 0%

*Please use the function by assigning trim or dial by key assignment according to usage.

*STEP operation setting is 1/2/5/10/20/25/50/100.
Please set MODE in AUX TYPE.

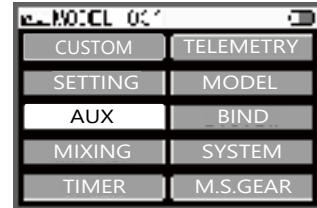

ENTER ↓ ↑ BACK



Setting of flap operation volume

Setting of mixing rate

STEP operation setting can be set in AUX TYPE

How to use each feature

CODE AUX

AUX

● The Code AUX function is used with SSL-compatible accessories, such as a Super Vortex Gen 2 and SV-D2 series ESC, PGS series Servos, and SGS-02 Gyros, whose Programming Parameters can be changed directly via the transmitter.

※ Code 10 compatible equipment is PGS servo, SGS-02, SUPER VORTEX Gen 2 PRO / Gen 2/ SV-D2, SUPER VORTEX Stock.

● Settings of two systems CODE AUX 1 and CODE AUX 2 are available.

※ CODE AUX is only available when you have selected CODE 5 or CODE 10 in AUX TYPE setting. (P.80-82) If you set the [MODE] setting to [USER], you can customize the respective code's display name.

※ When using the AUX channel as CODE AUX, be sure to set the AUX1 / AUX2 response mode type to [SHR] in [BIND] setting. (Refer to Page 85-87)

※ When using CODE AUX, never connect servos to CH3 and CH4 of the receiver to be used.

※ When using CODE AUX, assign the function to trim or dial with key assignment, or operate with the touch pad.

※ If assigned CODE AUX to switch, it can turn ON/OFF CODE AUX function. Setting value [0] is [OFF].

1) Select [AUX] with touch pad and confirm with enter operation.

2) Setting of code AUX (CODE AUX)
(CODE 01 ~ CODE 10)

Select AUX1 / AUX2 with the enter operation, and adjust the setting value with touch pad.

○ Setting range AUX TYPE: CODE 10 CODE 01~10: -100 to 100

○ Initial value AUX TYPE: CODE 10 CODE 01~10 : 0

※ Please set each parameter according to the equipment to be used.

※ When AUX TYPE is set to CODE 10, the CODE AUX setting status will be displayed as shown below on the servo monitor display.



ENTER ↓ ↑ BACK

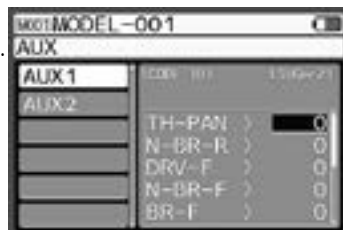

When TYPE setting is [CODE 10] and MODE setting is [SV - Gen2]

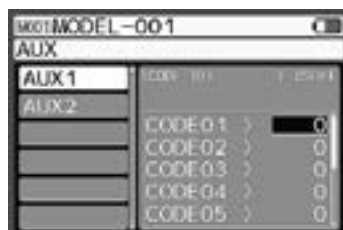

When MODE setting is [USER]

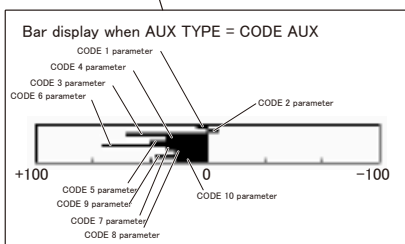

How to use each feature

MIXING

- Mixing between channels and mixing with a single channel is possible.
- Other than C-MIX 1 ~ 5, it includes tank (TANK), limiter function.

C-MIX1 ~ 5 (compensation mixing1 ~ 5)

Mixing [MIXING]

- Master channel can select either direct data or data containing calculation and trim (#ST etc).
- C-MIX is a combination of 5 systems of C-MIX 1 ~ C-MIX5 which can be simultaneously operated.
- It has offset function and base point of master mixing can be moved.
- Easy-to-understand graph display can be set.

Example) MASTER: ST, L10 %, R10 %, SLAVE: TH, OFFSET: 0

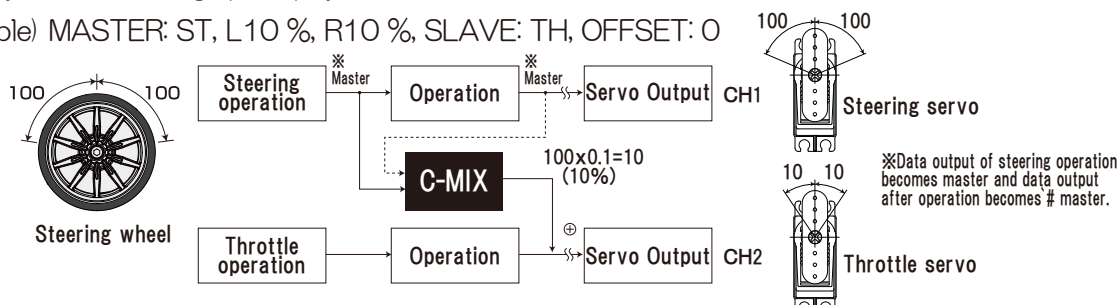

Supplement

Control of steering is generally steering operation "operation" servo output (CH1).

In the function of C-MIX, when steering is moved 100 as shown in the above figure, servo of CH1 moves 100 and simultaneously, 10 % (10) of the steering operation and servo of CH2 are operated.

Steering of this time (CH1) is called as master (MASTER) and CH2 that operated 10 % is called as a slave (SLAVE).

Setting	Name	Output data content
ST	Steering	Steering operation data
ST#1	Steering #1	Operation in steering that includes SPEED, CURVE
ST#2	Steering #2	Operation in steering that includes SPEED, CURVE, D/R, EPA
TH	Throttle	Throttle operation data
TH#1	Throttle #1	Operation in the throttle that includes SPEED, CURVE, OFFSET
TH#2	Throttle #2	Operation in the throttle that includes SPEED, CURVE, OFFSET, D/R, EPA, ALB
AUX1	AUX1	AUX1 operation data
AUX1#1	AUX1#1	Operation in AUX1 that includes SPEED, CURVE, OFFSET (when OFFSET is MOA / BR)
AUX1#2	AUX1#2	Operation in AUX1 that includes SPEED, CURVE, OFFSET, D/R, EPA, ALB (when OFFSET and ALB are MOA / BR)
AUX2	AUX2	AUX2 operation data
AUX2#1	AUX2#1	Operation in AUX2 that includes SPEED, CURVE, OFFSET (when OFFSET is MOA / BR)
AUX2#2	AUX2#2	Operation in AUX2 that includes SPEED, CURVE, OFFSET, D/R, EPA, ALB (when OFFSET and ALB are MOA / BR)

How to use each feature

- 1) Select <C-MIX1 ~ C-MIX5> of C-MIX by touchpad.
- 2) Setting of the master (MASTER)
 - Select the function of setting to master by touchpad.
 - Setting range ST, ST#1, ST#2, TH, TH#1, TH#2, A1, A1#1, A1#2, A2#2
- 3) Setting of a slave (SLAVE)
 - Select the function of setting to the slave by the touchpad.
 - Setting range ST, TH, A1, A2
- 4) Setting of mixing (RATE1 / RATE2)
 - Set the mixing volume of rate1 and rate 2 by the touchpad.
 - Setting range RATE1 : -150% ~ 150%
RATE2 : -150% ~ 150%
 - Initial value RATE1 : 0%
RATE2 : 0%
- 5) Setting of OFFSET (OFFSET)
 - In case of selecting function of the master with #, compensate the "gap" of trim by the function of offset.
 - Setting range -150 ~ 150
 - Initial value 0

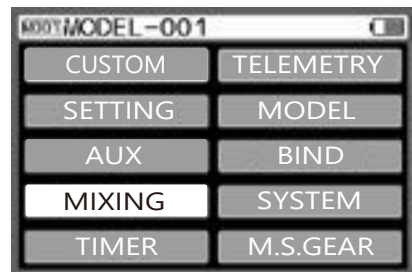

ENTER ↓ ↑ BACK

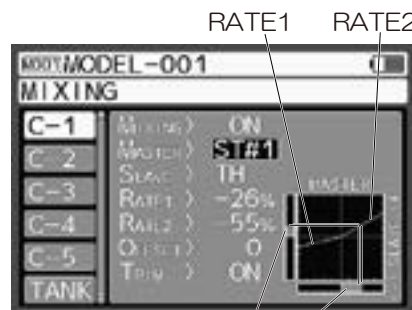

Bar graph of mixing volume with slave Bar graph of the master operation

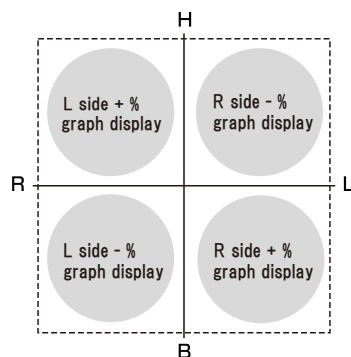

① Case wherein mixing is maximum when turning fully to right regardless of mixing at the time of turning fully to left by dial (AUX) etc. in case of changing base point of mixing of master

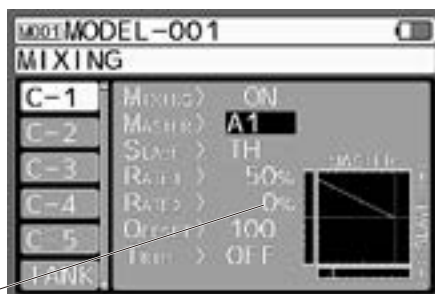
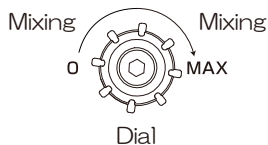

Can be 0 % as the offset is 100 and there is no operation on L side

How to use each feature

How to use each feature

Tank [TANK]

Mixing [MIXING]

- Function of operating infinite railroad track installed with caterpillar for tanks by setting TANK (tank). Sway turning, and super sway turning is possible by steering/throttle operation based on mixing steering and throttle channel.
- When TANK function is set, the case of only steering function becomes super sway turning and when combined with throttle operation, turning radius at the time of sway turning changes.

1) Select < TANK > of MIXING by touchpad.

2) Setting of tank

Set function of the tank by touchpad.

○ Setting range Tank : ON/OFF
 Forward : 0 ~ 100
 Reverse : 0 ~ 100
 Left : 0 ~ 100
 Right : 0 ~ 100

○ Initial value Tank : OFF
 Forward : 100%
 Reverse : 100%
 Left : 100%
 Right : 100%

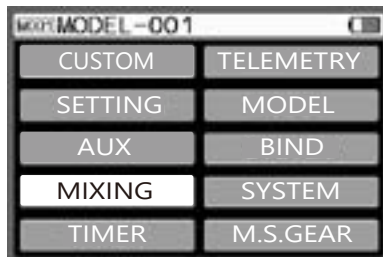

ENTER ↓ ↑ BACK



How to use each feature

Limiters [Limit]

Mixing [MIXING]

● Function of setting a limit (position above which operation is not performed) in servo operation. Used if servo operation volume exceeds due to duplication of mixing or for preventing damage to the linkage.

1) Select < Limit > of MIXING by touchpad.

2) Setting of Limit

Select channel for which limiter is to be set by touchpad.

○ Setting range

ST L : 0 ~ OFF(150)
 ST R : 0 ~ OFF(150)
 TH H : 0 ~ OFF(150)
 TH B : 0 ~ OFF(150)
 AUX1 H : 0 ~ OFF(150)
 AUX1 L : 0 ~ OFF(150)
 AUX2 H : 0 ~ OFF(150)
 AUX2 L : 0 ~ OFF(150)

○ Initial value

ST L : OFF
 ST R : OFF
 TH H : OFF
 TH B : OFF
 AUX1 H : OFF
 AUX1 L : OFF
 AUX2 H : OFF
 AUX2 L : OFF

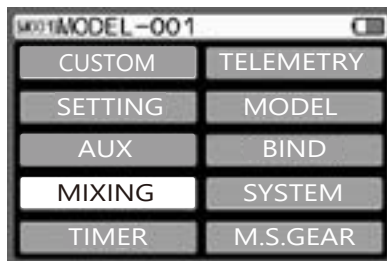

ENTER ↓ ↑ BACK

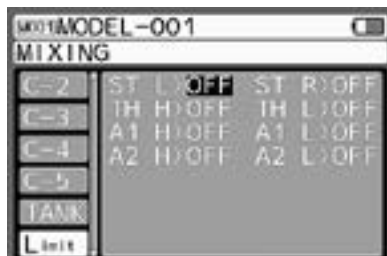

How to use each feature

TIMER

- Three timer functions of lap timer, interval timer, down timer are provided.
- Select timer and operate the select button then it will switch between the timer screen and the setting screen.
- ※ The function LED blinks during timer operation.

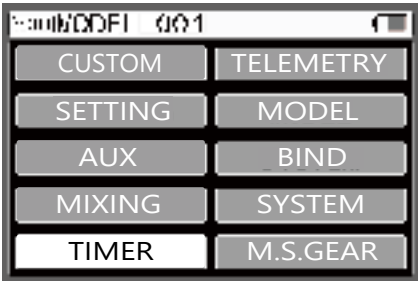
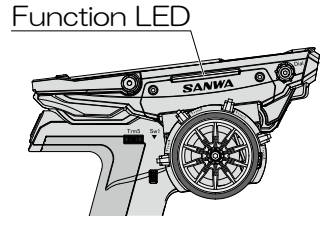

ENTER ↓ ↑ BACK

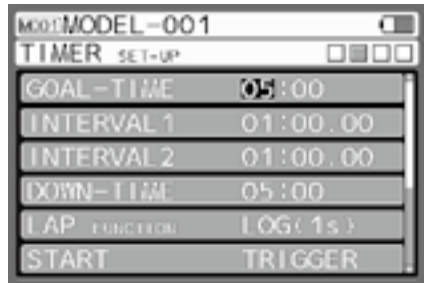

↔ Select operation

↕ Select operation

Select operation ↕

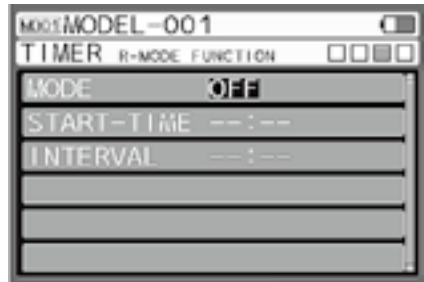
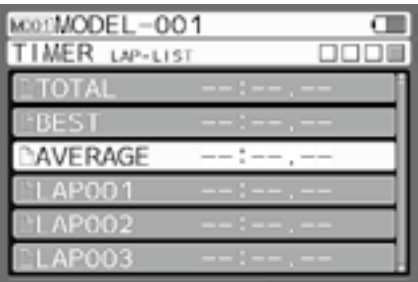

↔ Select operation

- Measured lap time can be checked by the LAP TIMER screen.

How to use each feature

How to use each feature

SETUP

TIMER

● Set various timers in the setup menu.

1) GOAL TIME SETTING [GOAL-TIME]

The alarm will be activated by setting the goal time.

- Setting Range 00 : 00 ~ 99 : 59 (00 : 01 unit)
- Initial Value 5 : 00

2) Setting of INTERVAL (Interval) [INT1/INT2]

Operate alarm for the set time at the time of running and use it as a criterion for target time.

- Setting Range 00 : 00 ~ 99 : 59.99
- Initial Value 01 : 00.00

3) Setting of DOWN TIME (Downtime)

Becomes criterion for running time of electric RC car or calculation of fuel consumption in engine RC car.

Can be set up to 99:59 in the unit of 1 second.

Can be changed over to up timer after completion of down timer and time passed after completion can be checked.

- Setting Range 00 : 00 ~ 99 : 59
- Initial Value 05 : 00

4) Setting of lap function (LAP FUNCTION)

Configure log (records) of telemetry data in conjunction with the timer.

- Setting Range OFF/ON(1s)/ON(10ms)/VOICE
- Initial Value LOG(1S)

※ Link LAP FUNCTION to lap timer.

※ LAP FUNCTION setting is [VOICE], [OFF] cannot record Telemetry Log data.

5) Setting of START

Timer start setting can choose TRIGGER/ KEY / STARTER.

Setting items TRIGGER / KEY / STARTER

Initial value TRIGGER

6) Setting of SYNC-START

Can be started by linking the respective timer function as per setting. (Only at the time of start)

Setting items LAP/INT 1 /INT2/DOWN

Initial value LAP, INT 1, INT 2

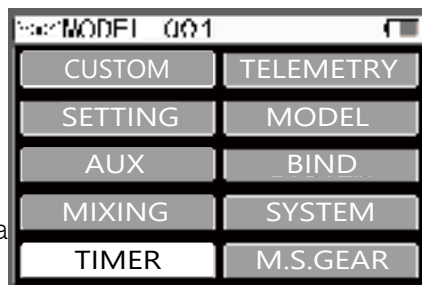

ENTER ↓ ↑ BACK

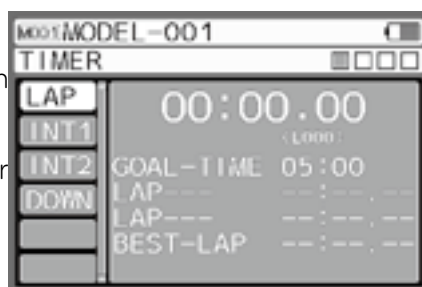

Select operation ⇅

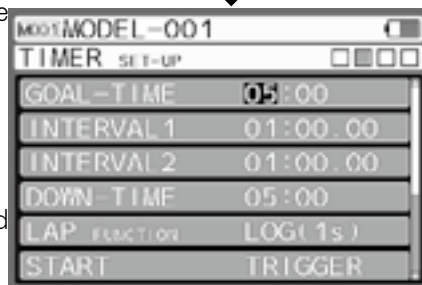

⇅

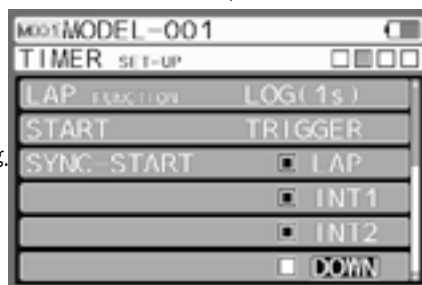

How to use each feature

How to use each feature

LAP TIMER

TIMER

- Each lap can be measured and recorded up to 999 laps. (Common to models)
- The pre-alarm (PRE-ALM) is loaded and the alarm rings automatically before the goal.

1) Select [TIMER] with the touchpad and confirm with ENTER operation.

2) Timer Select
Select [LAP].

3) Timer start

Lap timer will be ready to press and hold switch which set. Also, lap timer will be ready to enter [LAP] and then holding enter operation on timer display.

Then press the switch or enter on the display again to start timer. ※ The switch of the timer is set to SW1 with an initial value.

When you press and hold SW1 for a long time, the timer enters the start standby state, and when you press SW1 again or operate the throttle trigger, measurement starts.

4) Lap time is measured each time set switch or enter operation is operated.

※ Lap timer will start to measure after 3 seconds when press or enter.

5) End measurement

Press and hold SW1 to end the measurement.

6) Check of various lap time

Lap time measured can be checked in the LAP LIST.

Each lap time can be checked by operation of touchpad.

Total time, best lap, average lap can be displayed and lap time for each round can be checked. (Not possible on SETUP screen)

※ When the power switch is turned off with the timer running, the timer is reset.

※ If a timer is set in SW1 / SW2 and it is long pressed and held even other than the timer-setting screen, it enters the start standby state.

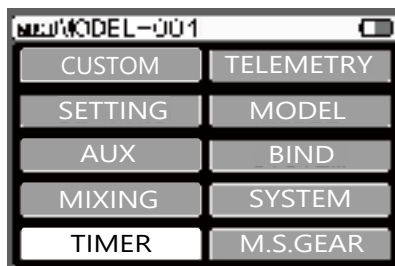

ENTER ↓ ↑ BACK



Select operation ⇅

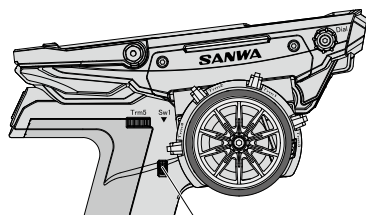
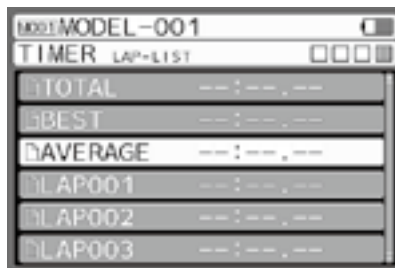

Switch 1
(SW 1)

How to use each feature

Interval timer 1/2 [INT TIMER 1/2]

TIMER

- Activate the alarm at the time set during driving, and use it as a guide for the target time.
- There are 2 systems in interval timer namely INT1 and INT2 and these can be operated simultaneously.

1) Select [TIMER] with the touchpad and confirm with enter.

2) TIMER SELECT

Select [INT] or [INT2] with the touchpad.

3) INTERVAL Setting (INTERVAL)

Set the interval timer, using [INTERVAL-1] or [INTERVAL-2] in [SETUP].

4) Interval Timer Start

Interval timer will be ready to press and hold switch which set by 5) setting of start or hold enter at timer screen. Then press the switch or enter at timer screen again to start timer.

*Interval Timer start default setting is link with [LAP] by [SYNC-START].

*Interval timer stop and restart when enter operation on timer screen.

6) End Measurement

Press and hold the switch or hold enter at timer screen to finish.

※ When the power switch is turned OFF with the timer running, the timer is reset.

※ If [INT1] or [INT2] stat setting is SW1 or SW2, long pressed and held enters the SW1 or SW2 to be the start standby state.

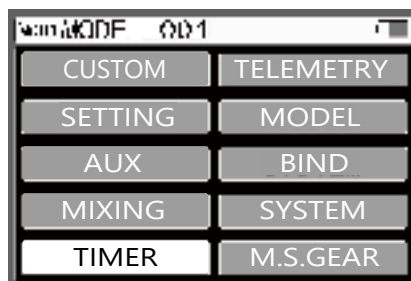

ENTER ↓ ↑ BACK

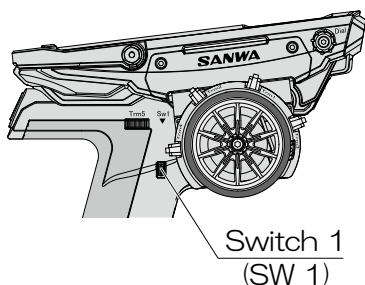
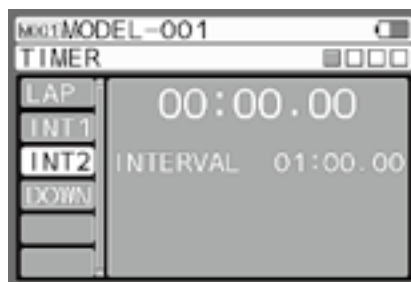

How to use each feature

DOWN TIMER

TIMER

- It is a measure of the fuel efficiency in the running time of the electric RC car and the engine RC car.
- 1-second units until 99: 59 can be set.
- After the down timer ends, it switches to the up timer and the elapsed time after the end can be checked.

1) Select [TIMER] with the touchpad and confirm the operation with enter.

2) TYPE Setting

Operate the select button and select [DOWN].

3) Down Timer Set

Please set Down Timer in [DOWN-TIME] of [SET-UP].

4) Down Timer Start

Down timer will be ready to press and hold switch which set by setting of start or hold enter at timer screen. Then press the switch or enter at timer screen again to start timer.

*Down timer stop and restart when enter operation on timer screen.

5) End Measurement

Press set switch or hold enter on menu display to end the measurement.

※ When the power is turned off with the timer running, the timer is reset.

※ If [DOWN] setting is SW1 or SW2 by KEY-ASSIGN, long pressed and held enters the SW1 or SW2 to be the start standby state, state.

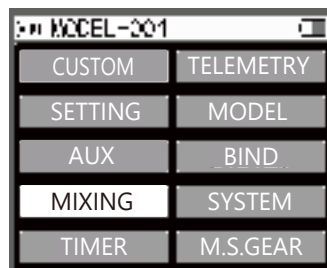

ENTER ↓ ↑ BACK

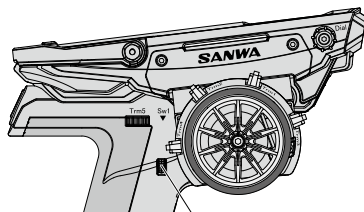

Switch 1
(SW 1)

How to use each feature

Racing Mode Function [R-MODE FUNCTION]

TIMER

● Do setting of R-MODE linked by timer by racing mode function.

1) Setting of MODE (Mode)

Link with timer and change setting of R-MODE (racing mode).

- Setting range R-MODE UP/R-MODE DOWN/OFF
- Initial value OFF

※ R-MODE UP Setting of R-MODE increases with the passage of the set time
 R-MODE DOWN Setting of R-MODE lowers with the passage of the set time
 OFF Setting is set to OFF.

2) Setting of START TIME (start time)

Operate function of function after the passage of the time set in START TIME.

- Setting range 00 : 00.00 ~ 00 : 00.00
- Initial value 00 : 00.00

3) Setting of INTERVAL (interval)

Setting of R-MODE changes at the time set in INTERVAL.

- Setting range 00 : 00.00 ~ 00 : 00.00
- Initial value -- : --. --

※ Timer can be set 0.01 second unit.

※ According to the setting of R - MODE UP / DOWN, racing mode changes as 1 → 2 → 3 → 4 → 5 and 5 → 4 → 3 → 2 → 1 after the passage of time, however, it stops at the upper or lower limit.

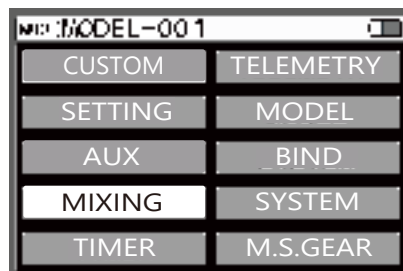

ENTER ↓ ↑ BACK

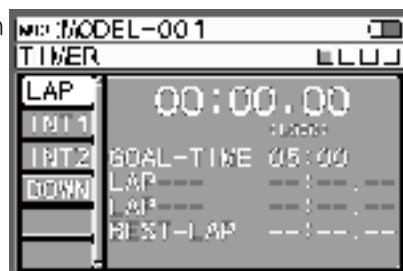

Select operation ⇅

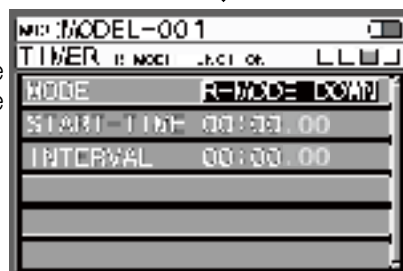

How to use each feature

TELEMETRY

- Menu for setting LOG DATA, TELEMETRY SETTING, GRAPH SETTING, TELEMETRY SWITCH, TELEMETRY MIXING, RX MODE associated with telemetry.
- For using telemetry function, it can be made compatible by using a compatible receiver, sensor, PGS servo, SUPER VORTEX series, SV-PLUS series.
- In telemetry, data such as temperature 2 systems, battery voltage, number of rotations can be checked by using the transmitter.

LOG DATA: Menu that manages the recorded log data.

TELEMETRY SETTING: Various settings of telemetry functions.

GRAPH SETTING: Setting at the time of displaying telemetry data as a graph.

TELEMETRY SWITCH: Various settings of switch that operates based on telemetry data.

TELEMETRY MIXING: Various settings for mixing telemetry data or data obtained from the sensor with each channel.

RX MODE: Function by which M17S transmitter becomes telemetry logger based on binding the compatible telemetry transmitter (M17S/M17/EXZES ZIII/MT-5/MT-R).

* RX MODE SETTING function is only available to use [RX MODE] (P.21) in Launcher function.

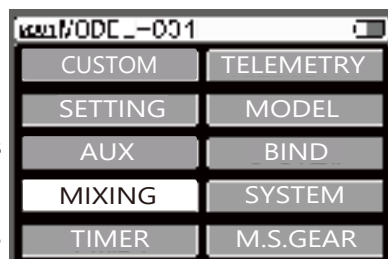

ENTER ↓ ↑ BACK

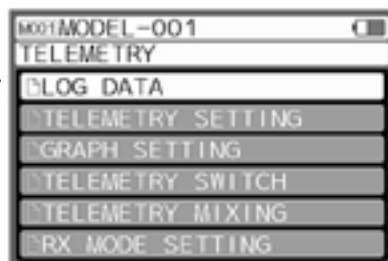

How to use each feature

LOG DATA

TELEMETRY

LOG DATA

● It is a function to manage log data such as reading logged data, graphing it, saving it to micro SD card, erasing log data and so on.

1) Select [TELEMETRY] with the touchpad and confirm with enter.

2) Select [LOG DATA] and confirm with enter.

3) Select the saved log data with the touchpad.
As you press enter the menu will be displayed, so select the menu and confirm by enter operation.

- VIEW DATA: Read logged data and graph it.
- DATA NAME: Edit file name of log data.
- EXPORT [CSV]: Convert to CSV format and save to micro SD.
- PROTECT: Conserve log data by protecting it.
- DELETE: Delete the log data.

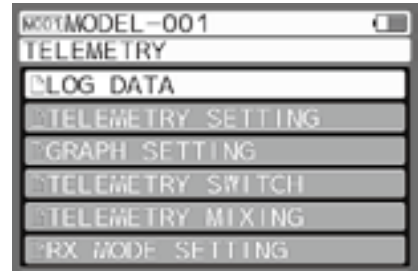

ENTER ↓ ↑ BACK

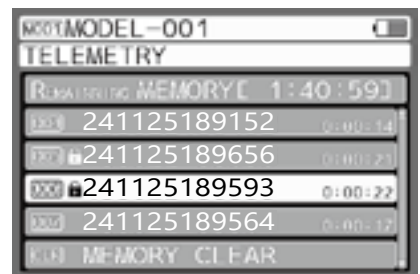

ENTER ↓ ↑ BACK

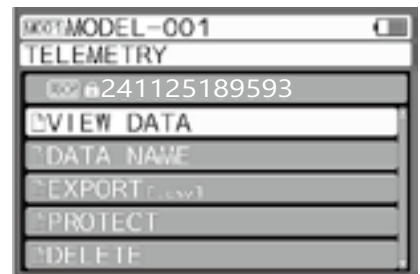

How to use each feature

How to use each feature

VIEW DATA

TELEMETRY

● It is a menu to read recorded log data and graph it.

1) Select [LOG DATA] with the touchpad and confirm with enter.

2) Select the log data to graph and confirm with enter operation.

3) When log data is selected, a menu will be displayed, so [VIEW DATA] is selected, the log data will be graphed and displayed.

4) Display size setting

When processing a graph while it is being displayed, the displayed size becomes the setting.

※ The setting of page 1 depends on the setting of DATA-LOG of TIMER SETUP.

- Setting range 2.75s /PAGE : 1 page/2.75s
- 5.5s/PAGE : 1 page/5.5s
- 11s/PAGE : 1 page/11s
- 22s/PAGE : 1 page/22s
- 44s/PAGE : 1 page/44s
- 88s/PAGE : 1 page/88s

LOG (10ms)

- 4.5m/PAGE : 1 page/4.5min
- 9.1m/PAGE : 11 page/9.1min
- 18.3m/PAGE : 1 page/18.3min
- 36.6m/PAGE : 1 page/36.6min
- 73.3m/PAGE : 1 page/73.3min
- 146.6m/PAGE : 1 page/146.6min

LOG (1s)

○ Default value: 4.5m/PAGE

Setting of display size

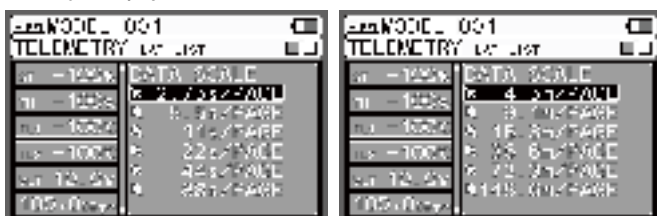

* Select operation at display size setting screen move to lap list.

5) Method of moving pages

If the select operation is carried out while graphing display page movement method can also be set.

○ Setting range: Cursor / Page / Wrap

○ Default: Cursor

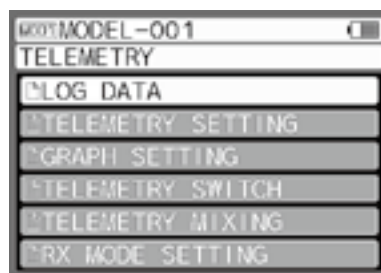

ENTER ↓ ↑ BACK

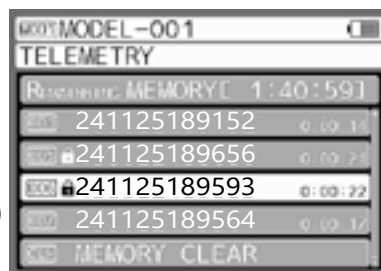

ENTER ↓ ↑ BACK

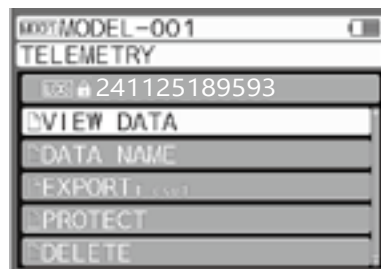

ENTER ↓ ↑ BACK

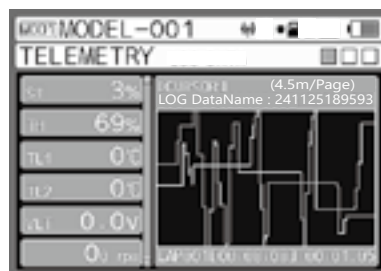

How to use each feature

DATA NAME	TELEMETRY
-----------	-----------

- This function changes the file name of the selected log data.
- The alphabet and symbols can be used in the file names.

1) Select [LOG DATA] with the touchpad and determine with Enter
 2) Select the log data to change the file name determine with Enter.

3) Setting of the data name
 Select DATA NAME and confirm with enter.
 Move and choose character by enter and select operation.
 When the cursor position is determined, it will shift to the selection of the input character.

4) Select the characters to enter with the touchpad.
 When the input characters are determined, input with enter operation.

○ Setting range: A~Z, a~z, 0~9, Symbols

※ When changing the selected character or moving the cursor of character input, cancel the operation by back operation.

5) When the character input is completed, the data name is switched by enter operation for [CHANGE] next to the data name.

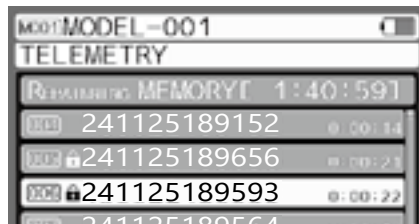

ENTER ↓ ↑ BACK

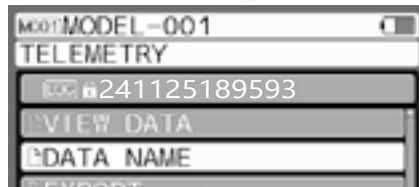

ENTER ↓ ↑ BACK

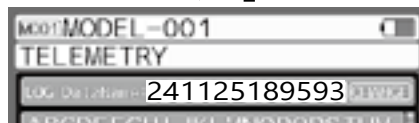

ENTER ↓ ↑ BACK

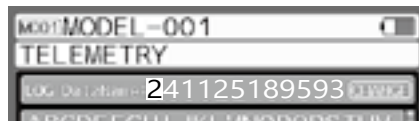

ENTER ↓ ↑ BACK

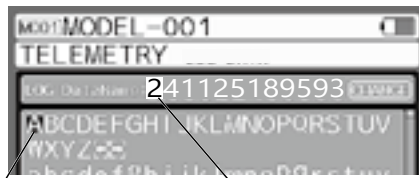

Character select cursor Character position cursor

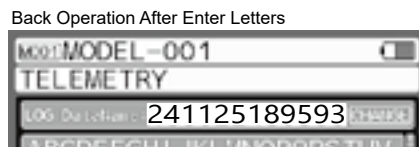

Enter After Down Operation

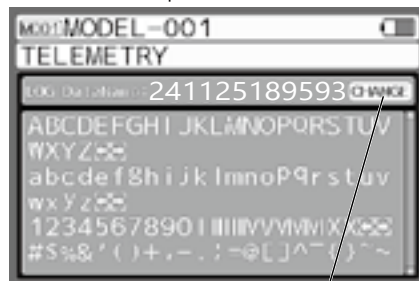

After completed select name, Enter [CHANGE]

How to use each feature

How to use each feature

EXPORT [.CSV]

TELEMETRY

● This function converts the selected log data so that it can be graphed with spreadsheet software etc. of PC (personal computer).

● To use the export function, a micro SD card is required.

1) Select the touch pad [LOG DATA] and confirm with enter.

2) Select log data to be exported and confirm with enter operation.
 ※ Enter operation will shift to CSV file name (file name change).

3) CSV File Name Setting

While changing the format file name can also be changed.
 Character input is the same as the method of data name, so please refer to that.

4) Conversion to CSV File format

Move the cursor to [SAVE], and confirm by enter operation.
 ※ Conversion work can be cancelled by back operation during data conversion.
 ※ After the data conversion, move the data to the PC via the micro SD card and display the graph.

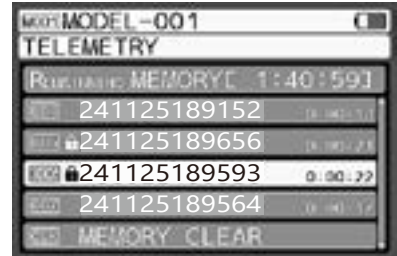

ENTER ↓ ↑ BACK

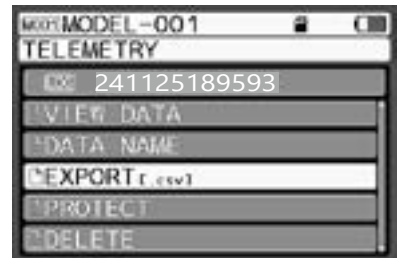

ENTER ↓ ↑ BACK

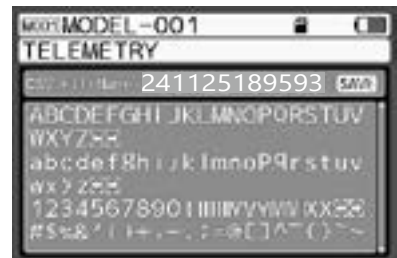

ENTER ↓



How to use each feature

How to use each feature

PROTECT

TELEMETRY

● It protects (protects) log data so that it is not deleted by mistake.

1) Select [LOG DATA] with the touchpad and confirm with enter.

2) Select the log data to protected and confirm with enter operation.
※ Protection is enabled/disabled each time the enter operation is performed.

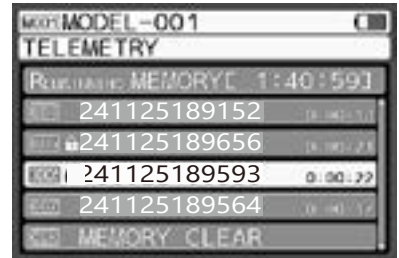

ENTER ↓ ↑ BACK

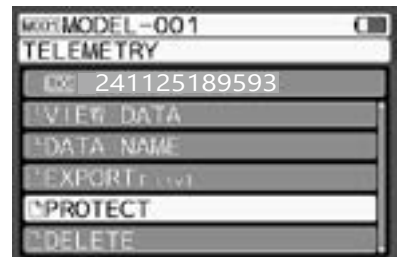

ENTER ↓

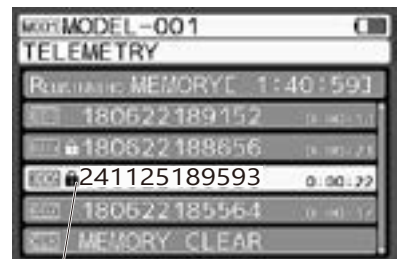

Protect mark

How to use each feature

DELETE

TELEMETRY

- This function deletes log data.
- Protected log data cannot be deleted.

- 1) Select [LOG DATA] with the touchpad and confirm with enter.
- 2) Select the log data to delete and confirm with enter operation. A confirmation screen will be displayed, so please operate according to the screen display.

Warning ● Since log data cannot be restored once deleted, care should be taken while handling the data.

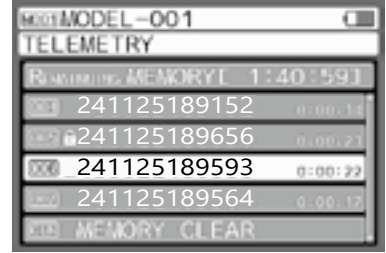

ENTER ↓ ↑ BACK

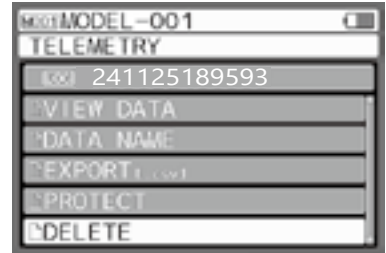

ENTER ↓

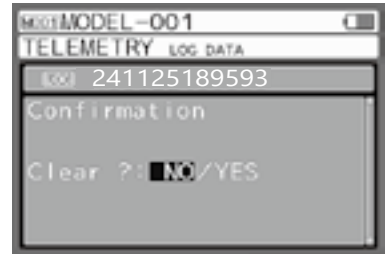

How to use each feature

TELEMETRY SETTING

TELEMETRY

● Set each function of telemetry. Select the function which is to be set with the select operation.

• SETTING TL1/TL2: TELEMETRY SETTING as temperature and speed

[NAME] can be changed up to 3 characters.

[UNIT] Switching of temperature settings and speed display (°C / F/ KM [unit of speed can be changed])

[MAX] Graph upper limit setting when displaying data in the graph

[ALERT] Operate the alarm at the set temperature.

※ Alarm OFF can also be set.

[MIN] Setting of graph lower limit value when the data was displayed in a graph

[VOICE] Read-aloud function can be set.

• SETTING RPM: Setting of frequency data and the speed calculated from frequency data.

[UNIT] Switch between frequency and speed display (RPM, km/h, mph)

[MAX SCALE] Setting of graph upper limit value when data was displayed in the graph.

• RATIO: RATIO (Ratio) when the optional rotation sensor is installed in the subtracted position, the rotation speed of the motor and the engine can be inversely calculated and displayed.

○ Setting range 0.001 ~ 64.999

○ Default setting: 1.000

• 10 COUNT DIST: Measure the moving distance when the motor rotates 10 times at the time of setting to speed display of [10 count distances], calculate the speed by setting that value and display it.

○ Setting range 1cm ~ 255cm

○ Default setting: 30cm

• VOLT: The alarm operates at the set voltage according to the telemetry data, and the LED also blinks.

[MAX VOLT] Setting of maximum voltage when displaying the graph

○ Setting range 3.1V ~ 9.0V, OFF

○ Default setting: 8.4V

[ALERT VOLT] Setting of alarm operating voltage

○ Setting range OFF/3.0V ~ 9.0V

○ Default setting: 3.8V

[HOLD TIME] Setting of hold time

※ It is a function to ensure that the alarm is not operated in case of the instantaneous voltage drop of throttle operation etc., in order to set the HOLD TIME.

○ Setting range 0.0sec ~ 5.0sec

○ Default setting: 1.0sec

[MIN VOLT] Setting of minimum voltage when the graph is displayed

○ Setting range 0.0V ~ 8.9V

○ Default setting: 3.0V

[VOICE] Setting of reading function when an alert occurs

○ Setting range ON/OFF

○ Default setting: OFF

• TELEMETRY: It also can turn ON/OFF telemetry after BIND.

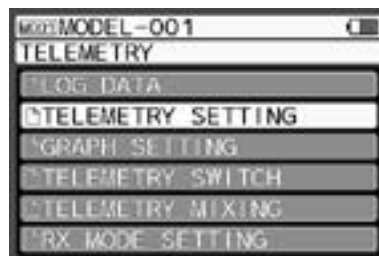

ENTER ↓ ↑ BACK

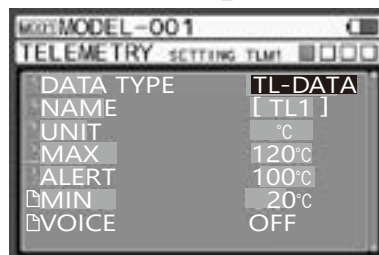

Select operation ↓

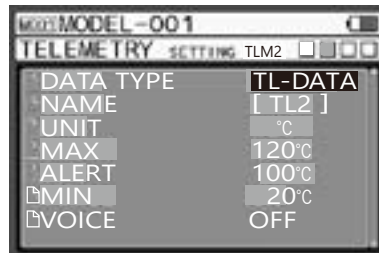

Select operation ↓

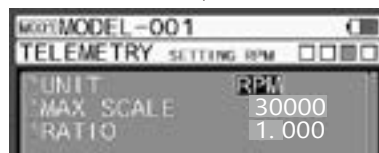

Select operation ↓

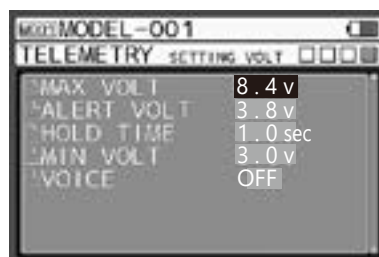

How to use each feature

Indicator

TELEMETRY

● M17S can check signal receiving conditions to use with RX-493i or RX-492i. The conditions can be used for devices glitch and checking receiver place on the car.

● There are 2 different types of data for checking signal condition.

1) Received Signal Strength (RSS)

Indicate signal strength which received from the transmitter.

The value will be changed by placing of receiver and antenna, RC circuit, places of operation.

Please take care the value is not decreasing when driving on circuit first time or replacing receivers.

2) Packet Delivery Ratio (PDR)

Indicate packet delivery ratio which received from the transmitter.

Values might be decreased when a lot of driver drive as the same time or using another 2.4 GHz devices at the same time.

In case of too low RSS values, PDR values are also decreased.

How to set and check data

1) Received Signal Strength (RSS) Setting

Select TELEMETRY SETTING in Telemetry menu by multi-selector, then press enter.

Change RX-DATA at DATA-TYPE (in TLM1)

2) Received Signal Strength (RSS) Setting

Select TELEMETRY SETTING in Telemetry menu by multi-selector, then press enter.

Change RX-DATA at DATA-TYPE (in TLM2)

After complete setting, go to the Telemetry display and can see RSS and PDR in the display.

※ About reference values

In case RSS is below 20, please check receiver where and how placed on the car.

Please change the receiver place to increase RSS values.

*Please refer on p.1 and p.9 for receiver replacing.

In case PDR is below 40, please turn off and restart the transmitter. Then, please check PDR values again.

※ About telemetry data

In case telemetry data displays “---”, transmitter does not receive telemetry data from receiver.

This does not indicate about receiver does not works and receiver does not receive transmitter signal.

Due to telemetry data signal from receiver is not stronger than transmitter signal, transmitter may not

get telemetry data from receiver due to distance which signal from receiver cannot reach.

Telemetry data on transmitter may display as “---” in this case.

In case of showing “---” on the transmitter, please check to see car movement by transmitter operation.

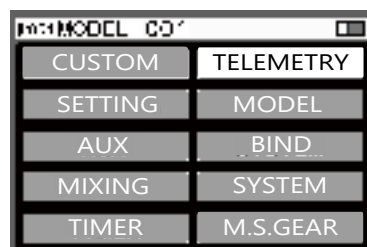

ENTER ↓ ↑ BACK

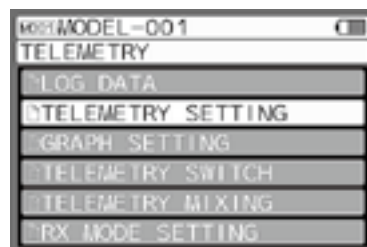

ENTER ↓ ↑ BACK

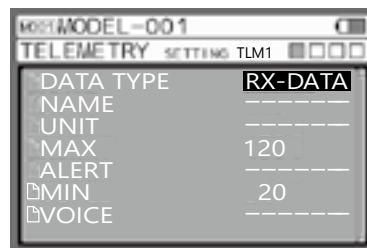

Select Operation ↓

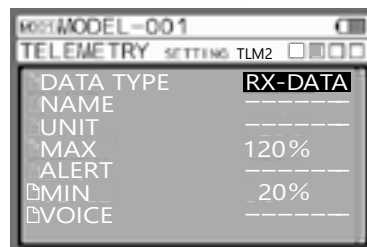

Telemetry Display

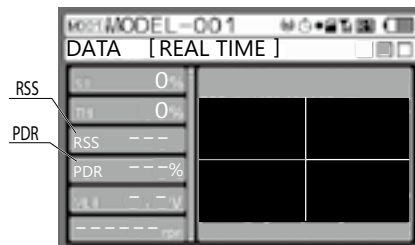

RSS
PDR

How to use each feature

GRAPH SETTING

TELEMETRY

● It is a function to select 3 items to display a graph when telemetry data is displayed in the graph.

1) Select [Telemetry] with the touchpad and enter with enter.

2) GRAPH SETTING

Select [GRAPH SETTING] with the touchpad and confirm with enter.

○ Setting range ST/TH/TL1/TL2/RPM/VLT

ST: Steering operation data
 TH: throttle operation data
 TL1: Telemetry data 1
 TL2: Telemetry data 2
 VLT: Receiver input voltage
 RPM: Frequency data

○ Default value

LINE1: ST (steering data)
 LINE2: TH (throttle data)
 LINE3: TL1 (telemetry data 1)
 LINE4: TL2 (telemetry data 2)
 LINE5: VLT (receiver input voltage)
 LINE6: RPM (frequency data)

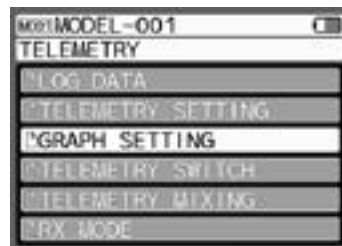

ENTER ↓ ↑ BACK

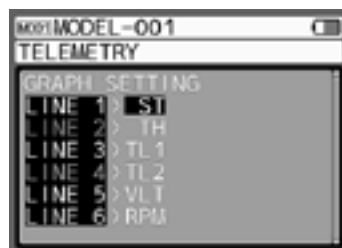

TELEMETRY SWITCH

TELEMETRY

● It is a function that can set switch operation with the data based on the change of the telemetry data.

- TRIGGER: Selects data as the basis of switch operation.
- BORDER: It becomes the setting of the operation standard such as temperature and voltage.
- ACTIVE: Select Hi (high) or Lo (low). Switch operation will start higher or lower than BORDER setting value.
- FUNCTION: Assigns movement.
- MODE: can select switch operation.

1) Select [Telemetry] with the touchpad and confirm with enter.

2) TELEMETRY SWITCH SETTING

Select [TELEMETRY SWITCH] with the touchpad and confirm with enter.

○ Setting Range TRIGGER: OFF/TEMP1/TEMP2/VOLT

BORDER: For temperature setting 0 to 150°C
 For voltage setting 3.0 to 9.0 V

ACTIVE : Setting of operating range with respect to the BORDER (Hi/Low)

FUNCTION: TIMER ON/OFF

RACING MODE

TH RATE

MODE: TOGGLE/ONE WAY

○ Default

TRIGGER : OFF

BORDER : ---

ACTIVE : ---

FUNCTION : ---

MODE : ---

Example)

TRIGGER : TL1

BORDER : 60°C

ACTIVE : Hi

FUNCTION : TH 50%

MODE : ONE WAY

For the operation set in such a way, when the telemetry temperature of TL1 exceeds 60 °C, throttle divergence is limited to 50% When MODE is ONE WAY, even if the temperature falls below 60 °C, it is not released.

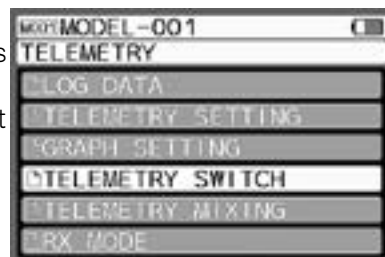

ENTER ↓ ↑ BACK

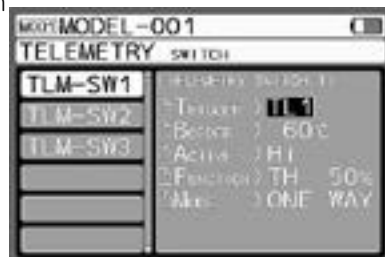

Precaution

● Since the telemetry switch can also cancel setting by the 3 systems of TLM-SW 1 ~ 3, depending on the setting, care should be taken for the setting contents.

How to use each feature

TELEMETRY MIXING

TELEMETRY

- Telemetry data and data obtained from the sensor can be mixed into each channel.
- The master channel can be selected from TLM 1/2 (telemetry data 1/2), VOLT (voltage), RPM (frequency) data.
- T-MIX has 3 systems of T-MIX 1 ~ T-MIX 3 and it can be operated simultaneously.
- It has an offset function and the base point of the master can be moved.
- Easy to understand setting can be done by graph display.

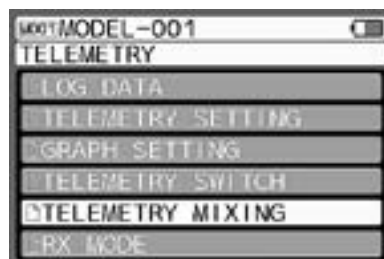
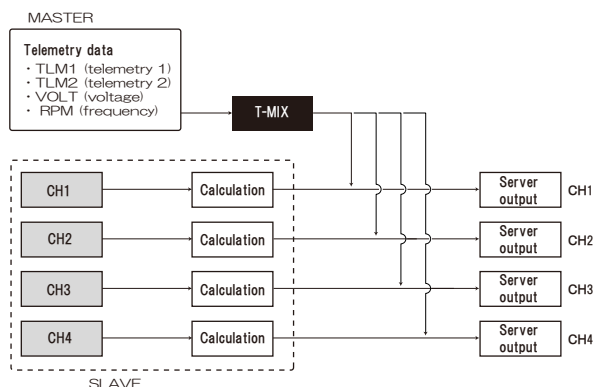

ENTER ↓ ↑ BACK

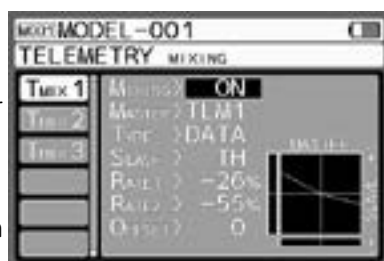

1) Select [Telemetry] with the touchpad and determine with enter operation

2) Setting of TELEMETRY MIXING

Select [TELEMETRY MIXING] with the touchpad and determine with enter operation

- MIXING (Mixing): Function ON / OFF
- MASTER (Master): Master setting of mixing operation
- TYPE (type): Master data setting
- SLAVE (slave): Slave setting of mixing operation
- RATE1 / RATE2: Mixing amount setting
- OFFSET: Changing the starting point of the master

※DATA: Mix the telemetry raw data to the slave as the master value

ALERT: Mix telemetry alert ON / OFF to the slave as the master value

○ Setting range

MIXING : ON/OFF

MASTER : TLM1, TLM2, VOLT, RPM

TYPE : DATA/ALERT

SLAVE : ST, TH, A1, A2

RATE1 : -150% ~ 150%

RATE2 : -150% ~ 150%

OFFSET : -150 ~ 150

○ Default value

MIXING : OFF

MASTER : TLM1

TYPE : DATA

SLAVE : TH

RATE1 : 0

RATE2 : 0

OFFSET : 0

How to use each feature

RX MODE SETTING

TELEMETRY

● By setting RX MODE SETTING (and BIND setting), the M17S transmitter can be used as a telemetry logger to monitor the operation and telemetry data from another compatible transmitter (M17S/M17/EXZES ZIII/MT-5/MT-R).

- 1) Select [TELEMETRY] with the touchpad and confirm with enter.
- 2) Setting of RX Mode Setting (RX MODE SETTING).
Select [RX MODE SETTING] with the touch pad and confirm with enter.
- 3) Set [MODULATION] according to the transmitter type to be monitored.

- Setting range FH5
- Default value FH5

※ Transmitter type M17S/M17/ EXZES ZIII/MT-5/MT-R

- 4) BIND with the transmitter to be monitored.
Put the transmitter to be monitored in the BIND state, then tap [ENTER] on the touch pad. The [ENTER] will flashes and then stop blinking when binding is complete.
※ Please note that STEERING POINT / THROTTLE POINT cannot be set unless BIND is completed.

- 5) Reading the steering operation amount
Select [STEERING POINT] by scrolling left or right on the touch pad.
Keep the transmitter to be monitor in neutral, and press enter to set the neutral point. Then, turn the steering wheel to the maximum left and then maximum right. When it is within range, [OK] will be displayed next to the value of NEUTRAL / LEFT END / RIGHT END, please follow the instructions on the screen.

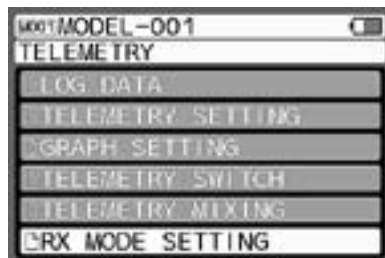

ENTER ↓ ↑ BACK

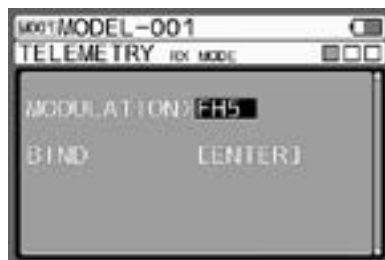

Select steering with touch pad

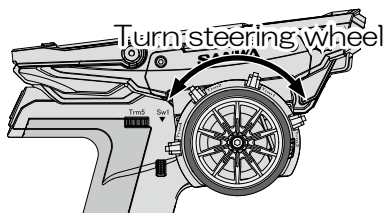

How to use each feature

6) Reading the throttle operation amount

Select [THROTTLE POINT] by scrolling left or right on the touch pad. Keep the transmitter to be monitor in neutral, and press enter to set the neutral point. Then, move the throttle trigger to the maximum throttle and then maximum brake. When it is within range, [OK] will be displayed next to the value, please follow the instructions on the screen.

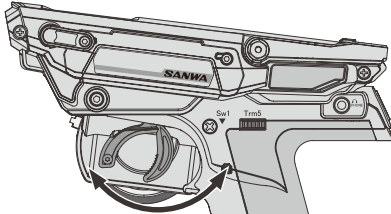

Move throttle trigger

Select throttle with touch pad



If the setting of RX MODE SETTING is correctly done, the data of transmitter being monitored will be displayed on the logger screen.



Warning

● RX-MODE SETTING function is only available when transmitter is put in RX-MODE in LAUNCHER menu (Refer to Page 21).

How to use each feature

MODEL

- Functions for model select, model name, model copy, model clear can be set.
- High-capacity EEPROM is built in and, it can store data of 250 models, M 01 ~ M 250.

MODEL SELECT

MODEL

- Stored model data of M 01 ~ M 250 can be easily recalled.

1) Select [MODEL] with the touchpad and confirm with enter.

2) Model select setting (MODEL SELECT)
Select [MODEL SELECT] with the touchpad and confirm with enter.

3) Model Selection
Select the model you want to recall with the touchpad.

○ Setting range M001 ~ M250

4) As the cursor is moved to the model to be recalled and confirmed with the enter operation, a message will be displayed on the screen, so please operate according to the display and perform model selection.

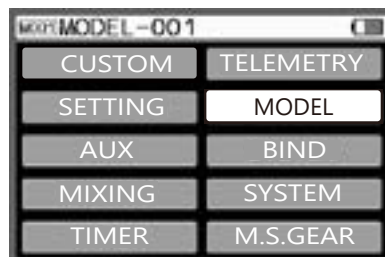

ENTER ↓ ↑ BACK

Current model display

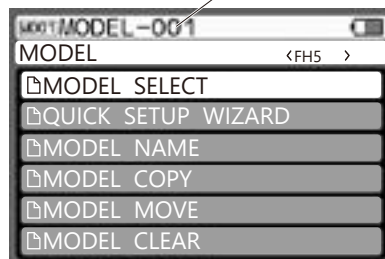

ENTER ↓ ↑ BACK

RF MODE display

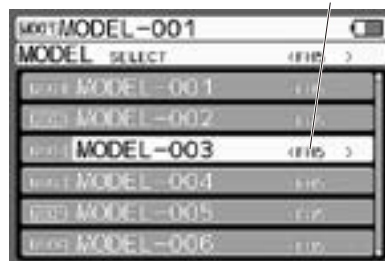

ENTER ↓ ↓ BACK

Model Select completion

① To model screen

① Model screen

② MODEL SELECT Screen

Supplement

- The M17S is equipped with the direct model select function. When the power switch of the transmitter is turned on while pressing SW2, the launcher function starts, and hence the models used in direct model selection can be easily opened. (P.79)

How to use each feature

Quick Setup Wizard < QUICK SETUP WIZARD >

● Quick Setup Wizard is easy set up function when setting up new RC car.

- 1) Select Model menu and Quick Setup Wizard.
- 2) Quick setup screen is displayed.
Quick setup wizard starts upon performing enter operation.
- 3) Change to model select screen and select the model to be set by the select operation.
Decide by enter operation while defining the model to be set.
- 4) The screen changes to a car type select screen. Select car type by the select operation.
Decide by enter operation while defining the car type.

Type setting

- Setting range
 - EP STANDARD
 - EP (PGS)
 - EP (DRIFT GYRO)
 - EP (SGS-02)
 - EP (SV-D2/SGS-02)
 - EP (SV-G2P/PGS)
 - GP ON (PGS)
 - GP OFF (PGS)
 - 1/5 GP CAR DUAL-ST
 - 1/5 GP CAR DUAL-BR
 - CRAWLER 4WS/MOA
 - TANK

○ Initial value EP CAR STANDARD

※ In each type, channel operation is done as follows.

TYPE-wise channel operation specification

CH	TYPE	EP CAR STANDARD	EP CAR PGS	EP CAR DRIFT GYRO	EP CAR SGS-02	EP CAR SV-D2/SGS-02	EP CAR SV-G2P/PGS	GP CAR ON-ROAD	GP CAR OFF-ROAD	1/5 GP DUAL-ST	1/5 GP DUAL-BR	CRAWLER 4WS/MOA	TANK
CH1	Steering	Steering	Steering	Steering	Steering	Steering	Steering	Steering	Steering	Steering 1	Steering	Steering F	Throttle L
CH2	ESC	ESC	ESC	ESC	ESC	ESC	ESC	Throttle /Brake	Throttle /Brake	Throttle /Brake R	Throttle	ESC F	Throttle R
CH3	AUX1	AUX1	GYRO	AUX1	CODE10 (SV-D2)	CODE10 (SV-G2P)	AUX1	AUX1	AUX1	Steering 2	Brake R	Steering R	AUX1
CH4	AUX2	CODE10 (PGS)	AUX2	CODE10 (SGS-02)	CODE10 (SGS-02)	CODE10 (PGS)	CODE10 (PGS-VPI)	CODE10 (PGS-XB)	Brake F	Brake F	Brake F	ESC R	AUX2

※ Select type matching with the RC to be used.

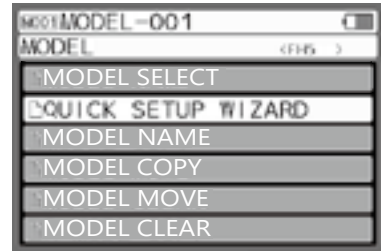

ENTER ↓ ↑ BACK

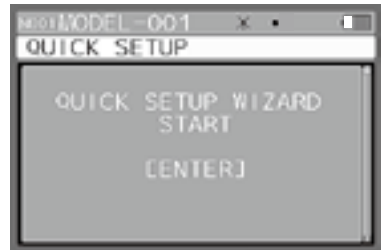

ENTER ↓ ↑ BACK

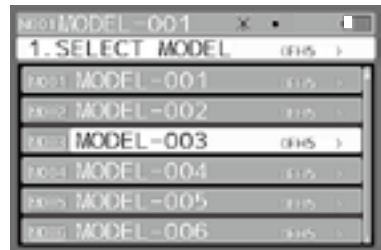

ENTER ↓ ↑ BACK

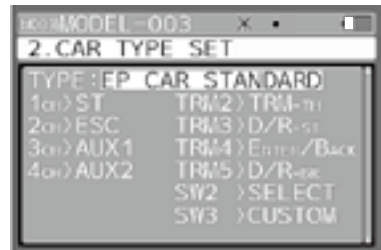

ENTER ↓ ↑ BACK



How to use each feature

How to use each feature

5) If car type setting is decided by enter, it changes to initialise (model initialisation) screen.

Initialise as per message.

6) When initialise (model initialisation) completes, it changes to RF mode selection screen.

Set RF mode according to the receiver to be used by up / down and decide by enter operation.

- Setting range FH5/FH5U
- Initial value FH5

- Compatible receiver FH5: RX-493i/RX-492i/RX49T/
RX-493/RX-492/RX-491

7) Upon deciding RF mode that matches with the receiver, it changes to the response mode selection screen.

Set response mode of each channel that matches with the servo or device to be used.

Set by up / down and decide by enter operation.

- Setting range NOR (normal/analog servo)
SHR (high response / digital servo)
SSR (servo response / SRG servo)
SUR (ultra response / PGS servo)
SXR (extreme response / PGS II servo)

- Initial value SHR (servo response / SRG servo)

8) Upon completing the setting of response mode, it changes to BIND (bind) setting screen.

Perform bind operation as per screen message.

9) Upon completing BIND (bind), it changes to the base setting screen. Do the setting of each channel. (Refer to P.41 ~ 43)

10) Upon completing base setting, the setup wizard completes. Changes to the top screen by enter operation.

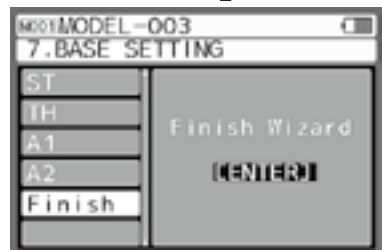
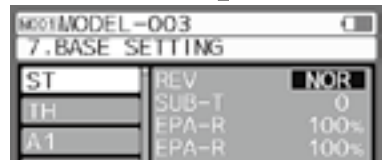
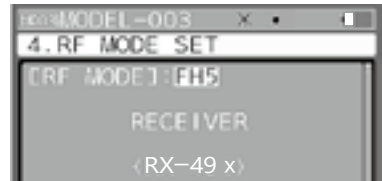

How to use each feature

How to use each feature

MODEL NAME

MODEL

● A model with the model name of up to 12 characters that contain alphabets, numbers, syllables and symbols can be registered.

1) Select [Model] using the touchpad and confirm by using the Enter operation.

2) Setting [MODEL NAME]

Select [MODEL NAME] using the touchpad and confirm by using the Enter operation.

3) Setting model

Using the touchpad, move the cursor to the position where character is to be input. Once the position is decided, confirm the cursor position by touching enter.

4) By using the touchpad, select the characters to be input. Once the characters to be input are determined, use the Enter operation and input them. Changing the alphabet/lower case/symbol/katakana is done by using the select button.

※ When the selected character is to be changed or position of the cursor where the character is to be input is to be moved, cancel the action using back operation.

○ Setting range A to Z, a to z, 0 to 9, aa to un
aa to tsu, symbols and spaces

5) When the character input is completed, using back operation to select file name. Then, press down operation to cursor to be [CHANGE] and enter [CHANGE] to switch model name.

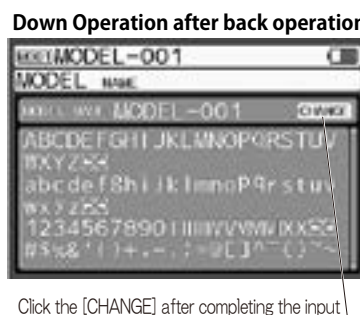
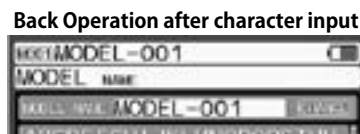
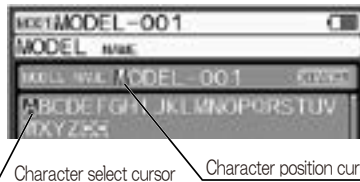
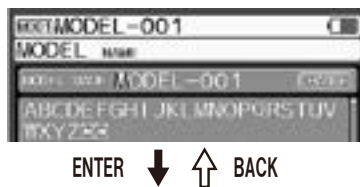
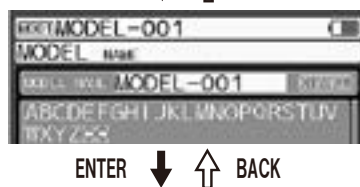
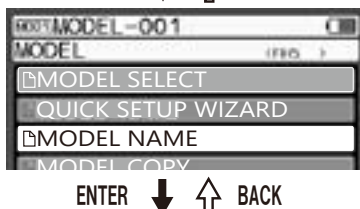
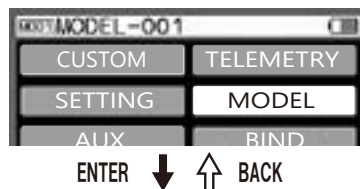

Alphabet, lowercase letters, symbols

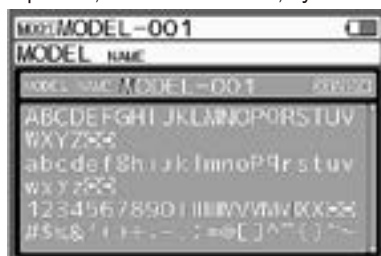

Katakana



How to use each feature

How to use each feature

MODEL COPY

MODEL

● The data of the selected model can be copied to another model.

1) Select [Model] using the touchpad and confirm by using the Enter operation.

2) Model copy setting

Select [MODEL COPY] using the touchpad and confirm by using the Enter operation.

3) Select a model for copying to

Select a model in which data is to be copied using the touchpad.

※ A model from which data is to be copied can be selected.

※ Micro SD card can also be selected for 'copy to' and 'copy from' models. When the micro SD card is selected in 'copy from' model and there is no model data in micro SD card, then nothing is copied.

4) When enter operation is performed, a message is displayed on the screen. Therefore, operate according to the display and copy the model.

● About model copy mode

• FULL

All the settings in the model data are copied.

• SYSTEM

Select the contents of SYSTEM of model data and copy them.

- KEY ASSIGN
- CUSTOM-LIST
- TELEMETRY
- AUX TYPE
- R-MODE

※ Copy from the selected above system.

• MODEL

Only the settings and set value of TH function AUX in model data are copied.

Select the model copy mode according to the application.

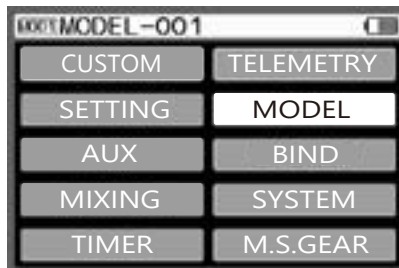

ENTER ↓ ↑ BACK

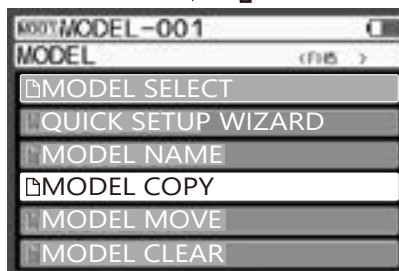

ENTER ↓ ↑ BACK

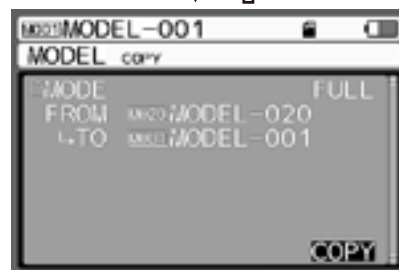

Copy source model Copy destination model Copy mode selection

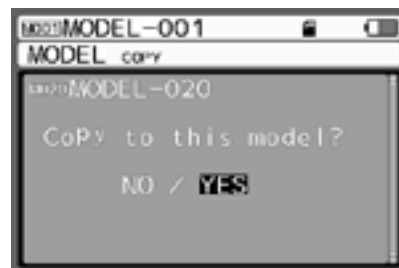

ENTER



How to use each feature

● Regarding copy from micro SD card

When copying the model, the main memory and micro SD card can select the specification of the copy source and copy destination.

It is can be selected by a Select operation when selecting a model on the copy destination selection screen.

1) When the model is selected, the specification of the copy source and copy destination can be selected other than from the main memory.

It switches according to Select operation.

- MEMORY (Main memory): 250 Memory
- SD CARD (Micro SD card): 250 Memory

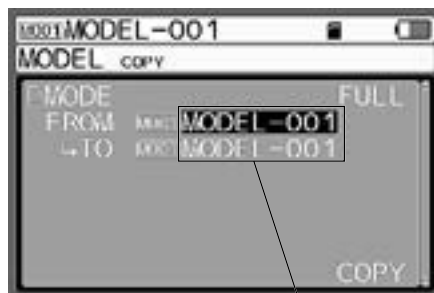

Enter Operation

Memory
(Transmitter)

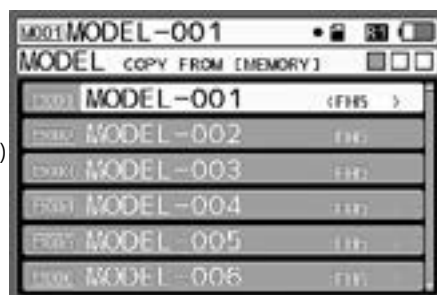

SD CARD



How to use each feature

MOVE

MODEL

● The order in which model data is arranged can be switched by switching the selected model data to another model data

1) Select [MOVE] with the touchpad and determine with enter operation

2) Setting of Move (MOVE)

Select [MOVE] with the touchpad and determine with enter operation

3) Selection of move

Select the model to be switched by the touchpad.

○ Setting range M01 ~ M250

4) Move the cursor to the model to be switched and perform the enter operation. Since a message is displayed on the screen, operate according to the display and select the model.

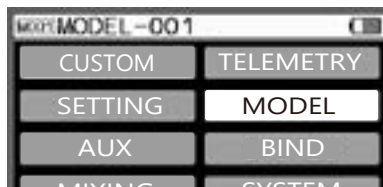

ENTER ↓ ↑ BACK

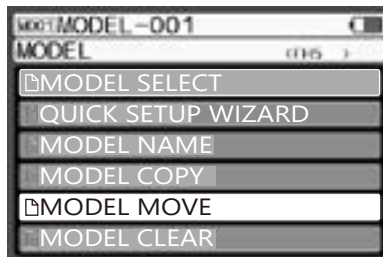

ENTER ↓ ↑ BACK

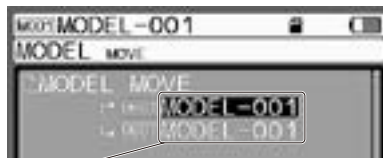

Move model selection

ENTER ↓ ↑ BACK

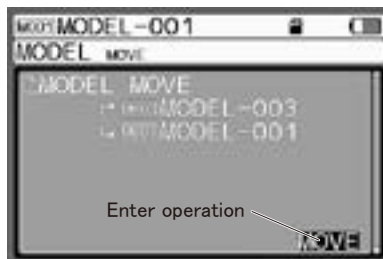

① Move model decision

ENTER ↓ ↑ BACK



② Move confirmation screen

←
ENTER

③ Move being executed



NO / Back to ④

How to use each feature

MODEL CLEAR

● It is the function of clearing (initialisation) the set data of the model.

1) Select the 'MODEL' using a touchpad and confirm by using the Enter operation.

2) Setting MODEL CLEAR

Select 'MODEL CLEAR' using the touchpad and confirm by using the Enter operation.

3) Select model data for performing MODEL CLEAR.

Model data in main memory and micro SD can be selected by using the Select operation.

4) When Enter operation is performed, a message is displayed on the screen; perform model clear according to the displayed message.

● About MODEL CLEAR mode

• FULL

All the settings in the model data are cleared.

• SYSTEM

Select the contents of SYSTEM of model data and clear them.

- KEY ASSIGN
- CUSTOM-LIST
- TELEMETRY
- AUX TYPE
- R-MODE

※ Clear from the selected above system.

• MODEL

Only the settings and set value of TH function AUX in model data are cleared.

Select it according to the application.

Select according to the application.

MODEL

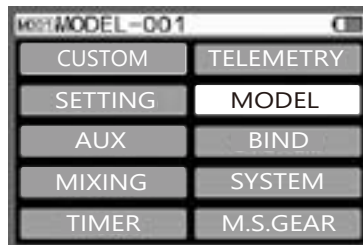

ENTER ↓ ↑ BACK

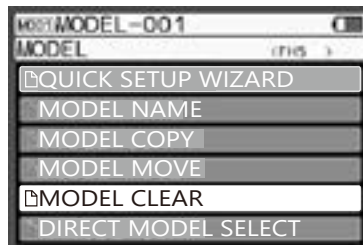

ENTER ↓ ↑ BACK

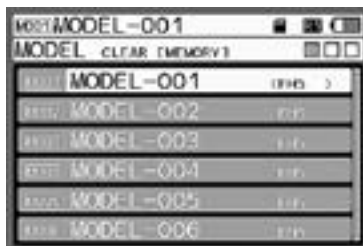

ENTER ↓ ↑ BACK

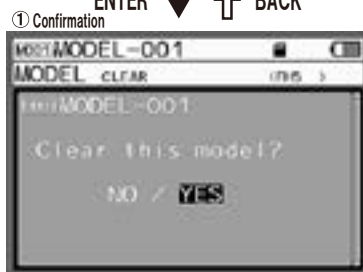

- NO → Return to MODEL screen
- YES → Clear execution To ②

② Clear



Return to the <MODEL> screen after displaying flash twice

How to use each feature

DIRECT MODEL SELECT

MODEL

● Direct model select can quickly select model when turning on the transmitter with holding assigned trim.

1) Select the 'MODEL' using a touchpad and confirm by using the Enter operation.

2) Setting DIRECT MODEL SELECT
Select 'DIRECT MODEL SELECT' using the touchpad and confirm by using the Enter operation.

3) Select model data to assign to each trim

○ Setting range M01 ~ M250

○ How to work Direct model select 1
Turning on the transmitter with holding TRIM1 and assigned model select.

○ How to work Direct model select 2
Turning on the transmitter with holding TRIM2 and assigned model select.

○ How to work Direct model select 3
Turning on the transmitter with holding TRIM3 and assigned model select.

○ How to work Direct model select 4
Turning on the transmitter with holding TRIM4 and assigned model select.

○ How to work Direct model select 5
Turning on the transmitter with holding TRIM5 and assigned model select.

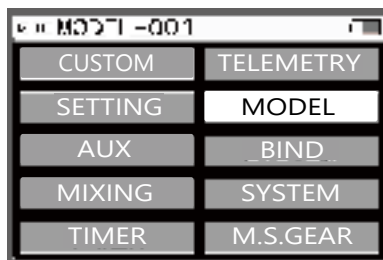

ENTER ↓ ↑ BACK

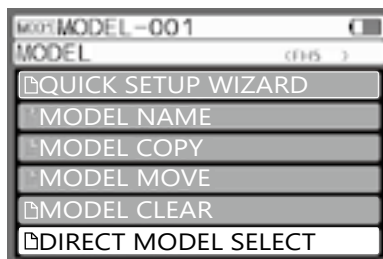

ENTER ↓ ↑ BACK

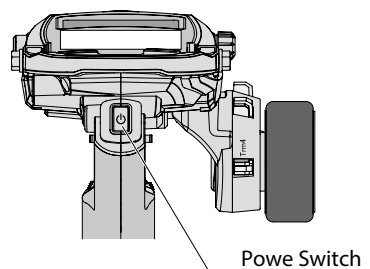
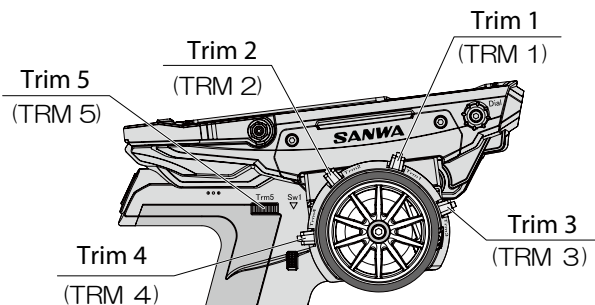
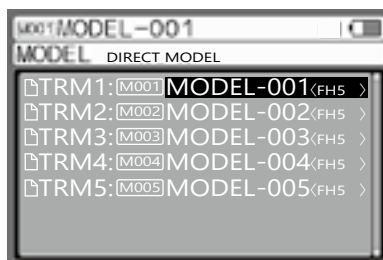

- Turn on the transmitter with holding trim which assigned model data.
- *Trim can work for direct model select either direction.

How to use each feature

BIND

Bind menu can connect transmitter and receiver. Before binding, RF mode and Response mode can be set for using servo, ESC, and so on.

BIND

SYSTEM

● Selects the output method for the receiver, and set the mode and bind the transmitter with receiver for the servo (analog/digital) and the speed controller.

1) Select [BIND] with the touchpad and confirm with enter.

2) RF MODE setting (RF MODE: radio wave output method)
Set the output method with the touch pad.

○ Output Method

- FH5 : RX-49* series
- FH5U : RX-49* series
- (RX-493i, RX-492i, RX-47T, RX-493, RX-492, RX-491)

○ Default FH5

*M17S is compatible with FH5 system receiver

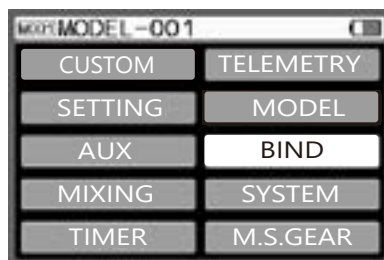

ENTER ↓ ↑ BACK

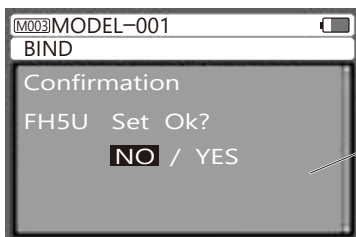

Confirmation screen

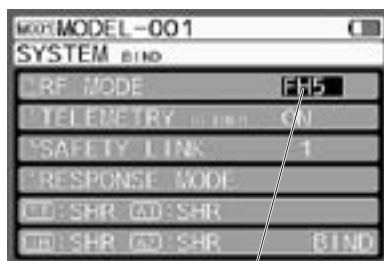

Output method

3) TELEMETRY RETURN Setting (telemetry return)

[※ Can be set only with FH5]

- Using a receiver compatible with FH5, set the transmission (return data) of telemetry data from the receiver with the touch pad.
- Setting range ON/OFF
- Default ON

※ TELEMETRY RETURN available receiver : RX-49* series

※ If you change the setting of TELEMETRY RETURN, please BIND again.

4) SAFETY LINK Setting

Set the SAFETY LINK with the multi selector.

- Setting range 1 ~ 50
- Default 1

※ If you change SAFETY LINK setting after BIND, please BIND again.

Supplement

- It is a function to prevent runaway etc. due to model select error. LINK Number can be set for each model.
- When model copy (FULL) is done, LINK Number is also copied.
- The Default is set to [01]. If you do not change the LINK Number, the BIND receiver will operate on all models.



Warning

- Please bind transmitter with receiver before using.
- Please bind transmitter with receiver before using new receiver.
- If changed Bind setting as response mode (SXR/SUR/SSR/SHR/NOR) setting, please rebind after changed. Setting change is completed by rebinding.

How to use each feature

BIND

- 5) Response Mode Setting
 - Set the response mode of each channel with the touchpad.
 - ※ Set the response mode of each channel according to the equipment to be used.
 - Response mode can be set for each channel.
 - Setting Range
 - NOR (Normal)
 - SHR (High Response)
 - SSR (Super Response)
 - SUR (Ultra Response)
 - SXR (Extreme Response)

○ Default: SHR

SYSTEM

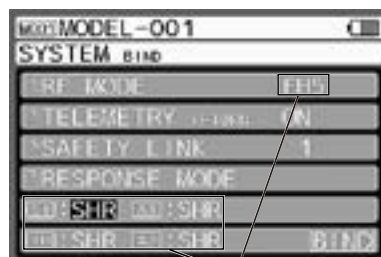

Please set same response setting with first M17 bind setting.

Important

- SXR/SUR/SSR is only compatible with SANWA official product.
- Please note that the analog servo does not work in SUR/SSR/SHR mode. If the analog servo is used in SUR/SSR/SHR mode by mistake it will not work properly and the servo will be broken so never use the analog servo in SUR/SSR/SHR mode. For digital servo (ERB, ERS series, Digital ERG series), it operates in NOR/SHR mode.
- The PGS servo operates in all response modes, and the SRG servo operates in SSR/SHR/NOR mode.
- The SUPER VORTEX/SV-PLUS series, HV-12 STOCK SPECIAL, HV-01 operate in SSR/SHR/NOR mode.
- In SUR/SSR/SHR mode, BL-RACER, BL-FORCE, F2000, F2200, F3000, F3300, SBL - 01, 02, 03CL does not operate. Ensure to use NOR mode.
- SV-08, HV-10, HV-12, F2500 operate in NOR/SHR mode.

6) BIND SETTING

- What is BIND: The M17S transmitter has a unique ID (individual identification) number and that ID number is stored in the receiver. It works only with a set of bound transmitter and receiver.

- 1] After finishing the settings in the BIND menu, set the BIND using the touchpad.
- 2] Move the cursor to [ENTER] in the BIND menu and with enter operation, the transmitter will be in BIND mode.
- 3] Connect the BIND plug to the receiver and turn on the power of the receiver.

※ PERFORM BIND WORK BY CONNECTING THE POWER SUPPLY TO THE CONNECTOR AVAILABLE AT THE TIME OF BIND. (CONNECT THE SPEED CONTROLLER TO CH2 IN CASE OF EP CAR)

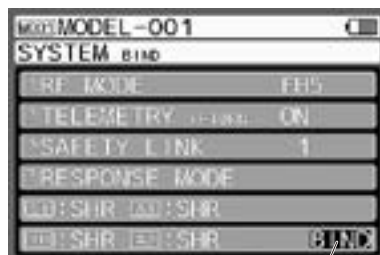

ENTER ↓ ENTER

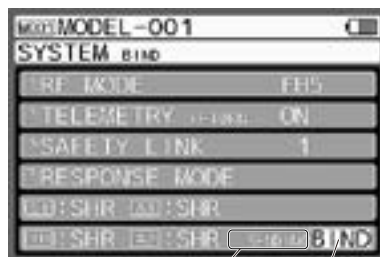

Flash Inverted

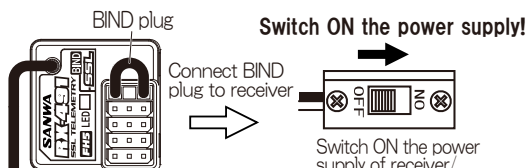

Note) Though the wire is not connected to the above-mentioned receiver, keep the servo and FET speed controller (excluding motor), battery in connected state.

- 4] If BIND is performed correctly, LED of the receiver is slowly flashing to be rapidly flashing. After checking rapidly flashing, please end the BIND operation of the transmitter using enter operation on the touchpad and take off the Bind Plug. If BIND is performed correctly receiver LED glows. Once the receiver LED glows confirm that the BIND operation has ended, by operating the servo etc.
- ※ If BIND operation cannot be performed correctly then redo from operation 2].

Receiver LED state

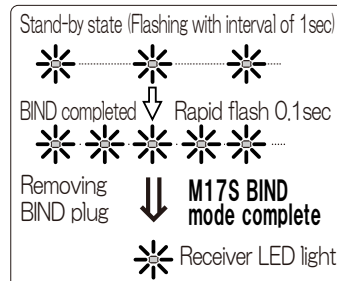

[Back to INDEX](#)

How to use each feature

⚠ Warning

- BIND is not performed at the time of shipment. Always perform BIND with RX-491 receiver before using.
- When the receiver is purchased newly, always perform BIND in transmitter and receiver.
- When settings in BIND menu and response mode settings (SUR/SSR/SHR/NOR) of the channel are done after performing BIND, perform BIND again. If re-BIND is not performed the settings changes are not reflected.

About Dual ID

- FH5 receiver series is possible to store 2 IDs. It is possible to combine
It is possible to operate with 2 bound receivers by storing (BIND) the ID of 2 peculiar transmitters to the receivers.
(* 2 transmitters cannot be simultaneously operated.) Compatible transmitter is M17/M17/EXZES ZIII/MT-R.
- The neutral position of the throttle and operation amount may vary depending on individual transmitter. The setting values of the transmitter may not be the same depending on the combination of the bound transmitter. Adjust with each transmitter according to the linkage of the car body.
- Always perform fail-safe setting with each transmitter.
- For all RF MODE and response mode of two transmitters to be bound, it should be the same. If it is not the same setting, then it is not possible to perform BIND with 2 transmitters.
- ※ If the transmitter of a different setting is bound as the second transmitter, the ID (identification number) of transmitter that was bound to the first unit is erased, and it is overwritten.
- ※ When BIND of the third transmitter is performed, the ID of the first transmitter is erased.

1] Regarding BIND setting of the second transmitter

The basic operation method is the same as the operation which is bound to the first machine.

Set the RF MODE and response mode as the same setting

2] When the cursor is moved to [BIND] in the BIND menu and enter operation is performed, the transmitter is in the BIND mode.

3] Connect the BIND/ SSL port plug to the receiver and turn on the power of the receiver.

4] When BIND is done correctly, the slow blinking of the LED receiver changes to medium speed blinking. When it changes to medium speed blinking, unplug the BIND plug, exit the BIND mode of the receiver and then reboot the receiver. Exit the BIND mode of the transmitter with the enter operation of the touch pad/ back operation. When BIND is correctly done, the LED receiver will turn on. When the LED receiver turns on, confirm the exit of the BIND by operating the servo, etc.

※ If BIND cannot be performed properly, try again from the 2] operation.

※ Dual ID operation can be check receiver LED is blinking for 1.5 second.

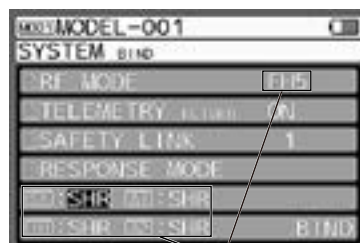

Please set same response setting with first M17 bind setting.

Receiver LED state

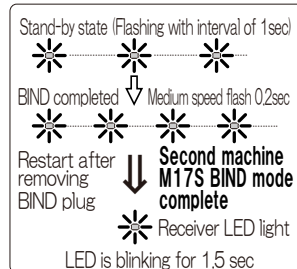

How to use each feature

KEY ASSIGN

SYSTEM

● Function and trim (increase or decrease in the set value of the function) can be assigned to switch (SW 1 to 3), trim (TRM 1 to 5) and DIAL of the transmitter, the function can be switched ON/OFF and set value can be changed while it is operating.

Function that are assigned to switch and trim at the time factory shipment

TRIM1: Steering trim (TRM-ST)

TRIM2: Throttle trim (TRM TH)

TRIM3: Dual rate ST (D/R-ST)

TRIM4: (ENTER/BACK)

TRIM5: Dual rate BR (D/R-BR)

SW1: Timer (TIMER)

SW2: Select (SELECT)

SW3: Custom (CUSTOM)

DIAL: Cursor

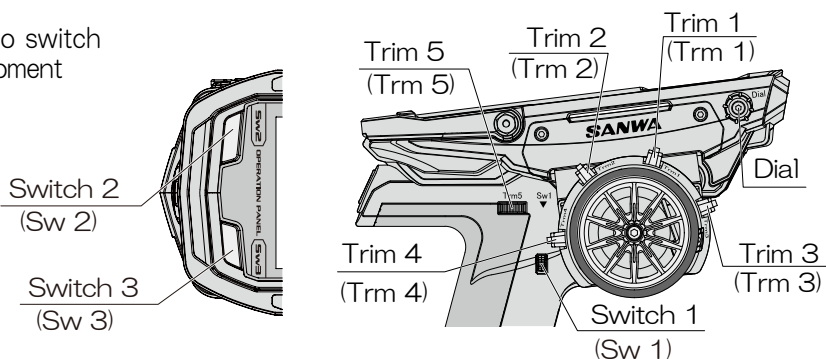

KEY ASSIGN SW

● Function can be assigned to transmitter switches (SW1, SW2, SW3) and function can be switched ON/OFF while it is operating.

1) Select [System] using the touchpad and confirm it by Enter operation.

2) Select [KEY ASSIGN] using the touchpad and confirm it by Enter operation.

3) Setting the switch (SW1/SW2/SW3)

Perform enter operation in [SW] and set the function to be assigned to the switch by using up/down operation.

Switch	Assignable functions
SW1 SW2	OFF, ALB, OFFSET, AUX1, AUX2, LAP, INT1, INT2, DOWN, C-MIX, C-MIX1~5, VOICE, SELECT, CUSTOM, R-MODE
SW3	OFF, ALB, OFFSET, AUX1, AUX2, C-MIX, C-MIX1~5, KEYLOCK, CUSTOM, ALT, MOTION

*C-MIX: Batch operation for C-MIX1~ C-MIX5

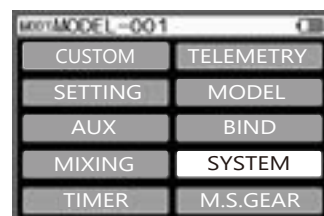

ENTER ↓ ↑ BACK

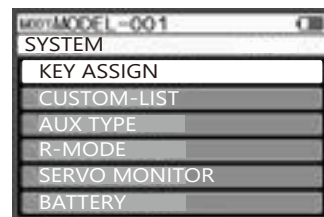

ENTER ↓ ↑ BACK



○ Setting Range

○ Default value SW1 : LAP
SW2 : SELECT
SW3 : ---

4) Setting the Mode

You can set the switch operation, but in some cases, you cannot perform the settings according to the function to be assigned.

- Setting Range TOGGLE (Switch to ON/OFF whenever it is pressed)
- PUSH (ON only when it is pressed)
- VOICE (TEMP1/TEMP2/VOLT/ALL)
- SELECT (NOR/REV)
- R-MODE (UP/DOWN)
- KEYLOCK/ALT (SW/TRM/ALL)

※ [SW3] Default setting is [CUSTOM]. Press on SW3 when turning on transmitter. It will be Custom menu.

※ You can assign another function to SW1/SW2, TRM1-5, and Dial by setting [ALT] to SW3. About range of switching can be set by [MODE] setting. You can switch the assigned function by the operation of SW3.

[Back to INDEX](#)

How to use each feature

KEY ASSIGN TRIM

- Set value of each function can be changed between trim 1 to trim 5 using dial.
- In STEP setting the setting of the variation width can be set by one time trim operation and operation direction can also be set by setting REV.

- 1) Select 'System' using the touchpad and confirm it by Enter operation.
- 2) Select 'KEY ASSIGN' using the touchpad, switch to 'TRIM' by the select operation, select the item to be set and confirm it by enter operation.
- 3) TRIM setting (TRM1/TRM2/TRM3/TRM4/TRM5)
Select 'TRM' whose setting is to be changed and set the function to be assigned, using touchpad operation.

○ Setting Range

Trim	Functions which can be assigned
TRM1	OFF, TRIM-ST, TRIM-TH, TRIM-A1, TRIM-A2, D/R-ST, D/R-TH, D/R-BR, D/R-A1H, D/R-A1L, D/R-A2H, D/R-A2L, SPD-ST-FWD, SPD-ST-RTN, SPD-ST-PNT, SPD-TH-FWD, SPD-TH-RTN, SPD-TH-PNT, SPD-A1-FWD, SPD-A1-RTN, SPD-A1-PNT, SPD-A2-FWD, SPD-A2-RTN, SPD-A2-PNT, CRV-ST-RATE, CRV-ST-PNT, CRV-TH-RATE, CRV-TH-PNT, CRV-BR-RATE, CRV-A1L-RATE, CRV-A1L-PNT, CRV-A2L-RATE, CRV-A2L-PNT, CRV-BR-PNT, CRV-A1-RATE, CRV-A1-PNT, CRV-A2-RATE, CRV-A2-PNT, ALB-POINT,
TRM2	ALB-STROKE, ALB-LAG, ALB-CYCLE, ALB-DUTY, OFFSET-PNT, CM1-RATE1, CM1-RATE2, CM1-OFFSET, CM2-RATE1, CM2-RATE2, CM2-OFFSET, CM3-RATE1, CM3-RATE2, CM3-OFFSET, CM4-RATE1, CM4-RATE2, CM4-OFFSET, CM5-RATE1, CM5-RATE2, CM5-OFFSET, AUX1, AUX2, AUX1-ACKER, AUX1-D/R, AUX1-LEFT, AUX1-RIGHT, AUX1-CENT, AUX1-TOE, AUX2-ACKER, AUX2-D/R, AUX2-LEFT, AUX2-RIGHT, AUX2-CENT, AUX2-TOE, AUX1-FLAP, AUX1-TH-FL, AUX2-FLAP, AUX2-TH-FL, AUX1-CODE1~5, AUX2-CODE1~5, AUX1-CODE1~10, AUX2-CODE1~10, R-MODE, ALB-SW, OFFSET-SW, CM1-SW, CM2-SW, CM3-SW, CM4-SW, CM5-SW, LAP-SW, INT1-SW, INT2-SW, DOWN-SW, CUSTOM, VOICE-REQ (ALL), CURSOR, ENTER/BACK, SELECT, INC/DEC
TRM3	
TRM4	
TRM5	
DIAL	

- Initial value
- TR1: TRM-ST (Steering trim)
 - TR2: TRM-TH (Throttle trim)
 - TR3: D/R-ST (Steering dual rate)
 - TR4: ENTER/BACK(Enter/Back)
 - TR5: D/R-BR (Brake dual rate)
 - DIAL: CURSOR(Cursor)

4) Setting the step (STEP)

Set the variation that operates by the one-time trim operation. Select the 'STEP' using the touchpad, confirm it by enter operation and set the variation.

- Setting range 1 ~ 100
- Initial value 5

5)Setting the operation direction

Set the operation direction when the trim operation is done. Select 'REV' using touchpad, confirm it by Enter operation and set the operation direction.

- Setting range NOR/REV
- Initial value NOR

※ VOICE-REQ (Voice - Request) : If setting to TRM1-5 or DIAL, transmitter is available to read out loud datas as telemetry data.

※ CURSOR : If setting to TRM1-5 or Dial, it can be cursor operation as move, increase, decrease values.

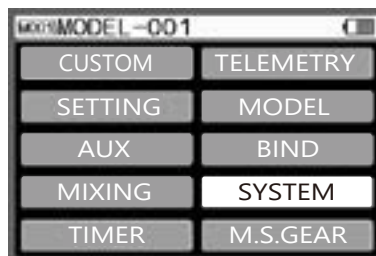

ENTER ↓ ↑ BACK

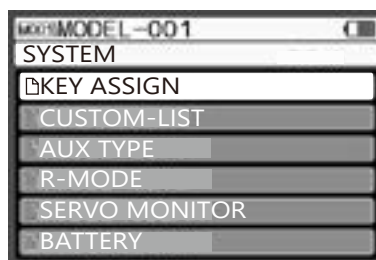

ENTER ↓ ↑ BACK

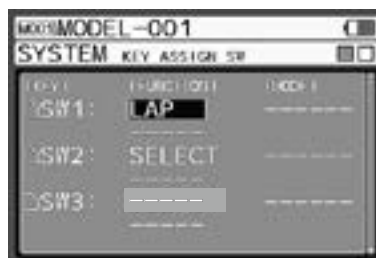

Select TRIM by scrolling to the right on the touch pad

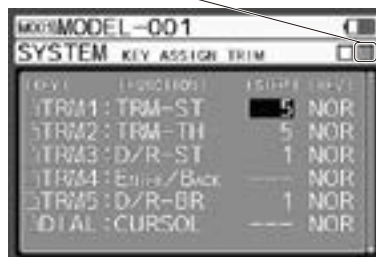

How to use each feature

CUSTOM-LIST

SYSTEM

- Desired menu can be built by setting in the custom list the menu that is to be used frequently. Custom list can be created in each model memory and a list of 4 pages can be created.
- Menu that is set in the custom list can be used in custom.

- 1) Select [SYSTEM] using the touch pad and confirm it by Enter operation.
 - 2) Select [CUSTOM-LIST] using the touch pad and confirm it by Enter operation.
 - 3) Setting the custom list
- Do the settings of channel/function/item using touch pad operation. 6 functions are assigned in 1 page.

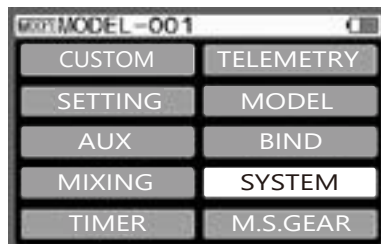

ENTER ↓ ↑ BACK

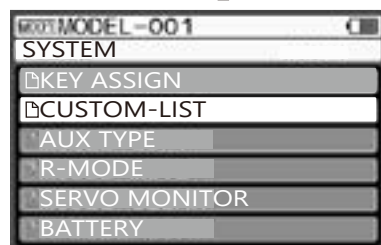

ENTER ↓ ↑ BACK

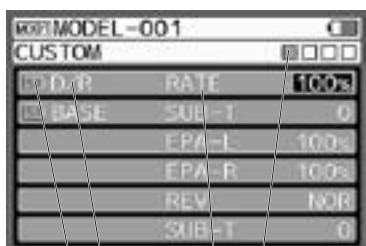

Channel selection
Function selection
Item selection
Page selection (Select button)

- ※ Custom list is set beforehand according to the type. Customise the custom list as desired.
- ※ Depending on the function/item there are things that cannot be set in a custom list, hence take care.

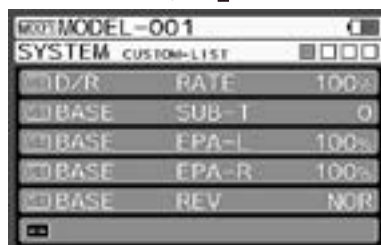

Custom list setting ↓

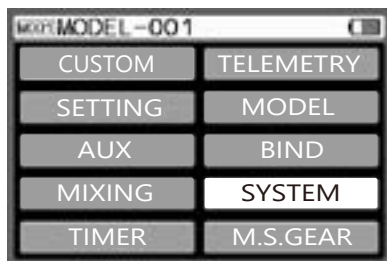
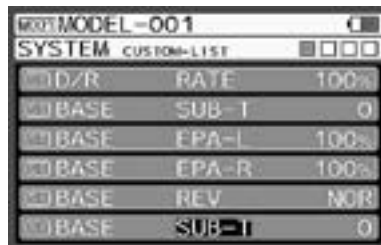

ENTER ↓ ↑ BACK

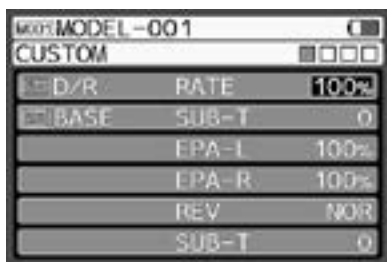

- ※ If set [CUSTOM] in any swiches or trims by KEY ASSIGN, it can be shortcut for custom menu. (SW3 default KEY ASSIGN setting is [CUSTOM])
- ※ If press and hold enter operation , channel setting will set "[--]."
- ※ If did not assign on [CUSTOM-LIST], it will skip on CUSTOM menu.

How to use each feature

AUX TYPE

SYSTEM

● It is a function for setting the operation of AUX1, AUX2 (3ch, 4ch).

- 1) Select 'System' using the touch pad and confirm it by Enter operation.
- 2) Select 'AUX TYPE' using the touch pad and confirm it by Enter operation.
- 3) Setting of AUX TYPE is done using the touch pad

○ Setting range

TYPE	MODE
STEP	1/2/5/10/20/25/50/100
POINT	2/3/4/5/6
4WS	2mode/3mode/4mode
MOA	1/2/5/10/20/25/50/100
BR-MIX	---
DUAL-ST	---
BOAT	1/2/5/10/20/25/50/100
CODE10	USER/SV-Gen2/AUX1/PGS/AUX2

○ Initial value AUX1: STEP MODE: 5
 AUX2: STEP MODE: 5

※ When you set AUX TYPE to CODE 10, you can change the settings of the corresponding device from the transmitter. PGS servo/SUPER VORTEX Gen 2 PRO/Gen 2/STOCK/SV-D2/SGS-02 will be changed to equipment compatible with CODE 10.

※ When the AUX TYPE setting is set to CODE 10, do not connect any other device which is not corresponding to AUX 1, AUX 2 (3ch, 4ch) of the receiver. If you connect any non-compatible device, the device will be damaged.

※ Refer to page 42 for POINT AUX and page 47 for CODE AUX.

※ When the MODE is set to USER with CODE10, you can register the name of each item freely.

※ Enter to [USER] at [MODE] in [AUX TYPE], move to [NAME/DEFAULT EDIT] menu.

※ [NAME] will be changed after edited [NAME/DEFAULT EDIT] menu. Changed [NAME] data will be back to default setting with holding enter operation.

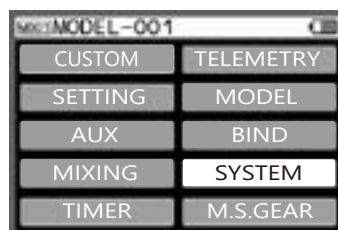

ENTER ↓ ↑ BACK

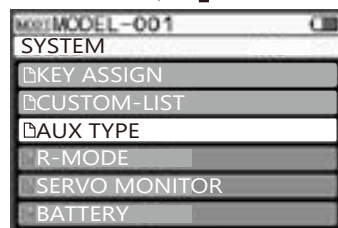

ENTER ↓ ↑ BACK

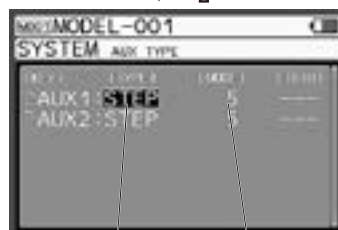

Type switching Mode setting

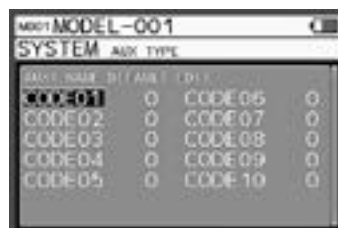

How to use each feature

Racing mode [R-MODE]

SYSTEM

- It is a function to adjust the running characteristics of the RC car by switching the racing mode so that the function corresponding to the racing mode can respond to the changes in the RC car and the road conditions.
- For each model memory, the function corresponding to the racing mode may have the set values for R1 to R5 separately, and it can be switched to the switch assigned while traveling.
- In the default setting, ON/OFF operation of the R-MODE is not assigned to the switch.

1) Select [SYSTEM] using the touch pad and confirm by enter operation.

2) Select [R-MODE] using the touch pad and confirm by enter operation.

3) Perform the racing mode operation and setting of the corresponding function by touch pad
Select the channel by select operation.

○ Setting Range R-MODE : OFF/2/3/4/5

Corresponding function: Each function ON/OFF
R-DERAY 0 ~ 100%

○ Default settings R-MODE : OFF

Corresponding function: Each function OFF
R-DERAY 0%

○ Corresponding function

ST/TH: D/R, SPEED, CURVE, TRIM, R-DERAY
AUX: D/R, SPEED, CURVE, TRIM, AUX, R-DERAY
MIXING: MIXING (C-MIX 1-5)

4) Set the function of the R-MODE to the switch so that you can switch the racing mode by making operations during traveling.

It is possible to change to trim lever or switch using Assign function. (P88, 89)

※ Set in accordance with the changing the SUPER VORTEX settings, tire wear and changes in the road conditions.

※ R-DELAY is slowly changing for the servo position in case of switching R-MODE is change a lot of servo position.

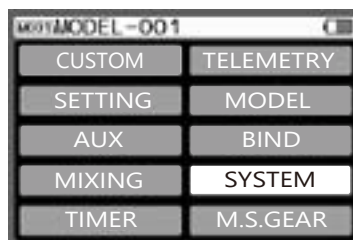

ENTER ↓ ↑ BACK

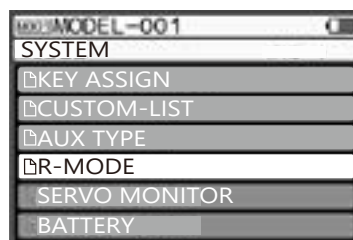

ENTER ↓ ↑ BACK



Channel selection



Racing mode indication



How to use each feature

SERVO MONITOR

SYSTEM

- The servo output operation of each channel is displayed as a bar graph, and the servo operation can be virtually confirmed.
- The operating condition will be easy to understand while setting functions such as exponential and ARC by using this function.

- 1) Select [SYSTEM] with the touchpad and confirm with enter.
- 2) Select [SERVO MONITOR] with the touchpad and confirm with enter.
- 3) Since the operation display screen is displayed with the enter operation, verify the operation with the bar graph.

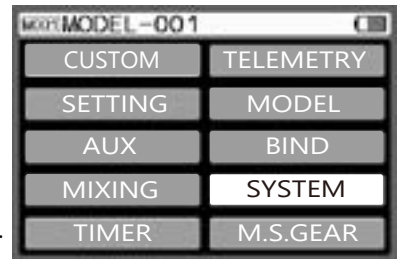

ENTER ↓ ↑ BACK



ENTER ↓ ↑ BACK

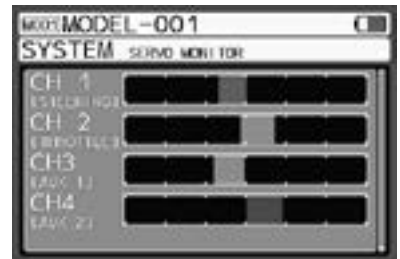

How to use each feature

BATTERY

SYSTEM

- You can change the voltage settings of transmitter battery alarm.
- The alarm settings can simply be carried out by selecting the Type [Li-Pox1 (Lithium polymer), CUSTOM].
- ※ When you select custom by Type, you can set the ALERT VOLT for setting the voltage at which the alarm starts and LIMIT VOLT for lower limit voltage.
- TH SLOW (Throttle slow) is a function that puts a limit on the operation quantity on the throttle high side (40%) when battery voltage of transmitter reaches the voltage of LIMIT VOLT. (Fail safe function) when reaching the ALERT VOLT, the operation quantity on the throttle high will be 80%.

- 1) Select [SYSTEM] using touch pad and decide by Enter operation.
- 2) Select [BATTERY] using touch pad and decide by Enter operation.
- 3) Type settings (TYPE)
Set the Type (TYPE) corresponding to the battery used by touch pad.

- Setting range Li-Pox1 (Lithium polymer)
CUSTOM (Custom): ALERT VOLT 3.0 ~ 5.0v
LIMIT VOLT 2.7 ~ 5.0v

- Default value Li-Pox1 (Lithium polymer)

 **Caution** ● At the time of using Li-Po cell, if the ALERT VOLT and LIMIT VOLT are lowered and used by Custom, there is possibility of Li-Po battery getting damaged. Do not use the Custom function when you use an original Li-Po battery of Sanwa.

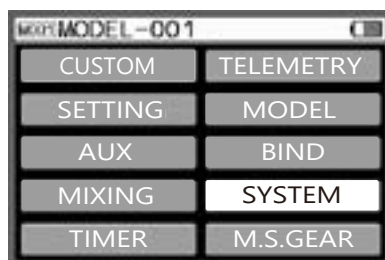

ENTER ↓ ↑ BACK

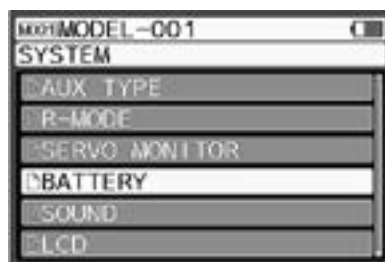

ENTER ↓ ↑ BACK

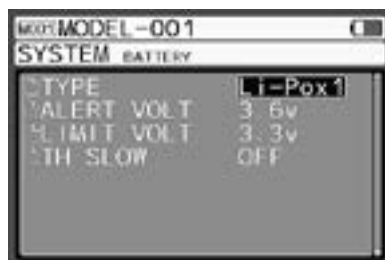

How to use each feature

SOUND

SYSTEM

● You can set the key operation, trim, operating sound of switch, performance of the vibrator during operation.

1) Select [SYSTEM] using touch pad and decide by Enter operation.

2) Select [SOUND] using touch pad and decide by Enter operation.

3) Sound and volume, vibrator settings

You can switch sound (sound quality) and volume (sound volume), parameter with Select operation.

Select the items for which the settings are to be changed and then adjust.

○ Set Items

KEY-CLICK
TLM1
TLM2
VOLT
LAP
INTERVAL 1
INTERVAL 2
DOWN
OFFSET
WARNING
VOICE

○ Setting Range

SOUND : 1 ~ 9
VOLUME : 0 ~ 5
VIBRATION : 0 ~ 5

○ Default value

KEY-CLICK : SOUND 1/VOL 4/VIB 3
TLM1 : SOUND 2/VOL 4/VIB 0
TLM2 : SOUND 3/VOL 4/VIB 0
VOLT : SOUND 4/VOL 4/VIB 0
LAP : SOUND 5/VOL 4/VIB 0
INTERVAL 1 : SOUND 6/VOL 4/VIB 0
INTERVAL 2 : SOUND 7/VOL 4/VIB 0
DOWN : SOUND 8/VOL 4/VIB 0
OFFSET : SOUND 1/VOL 4/VIB 0
WARNING : SOUND 9/VOL 4/VIB 0
VOICE : SOUND --/VOL 4/VIB --

※ Voice settings are only for VOLUME.

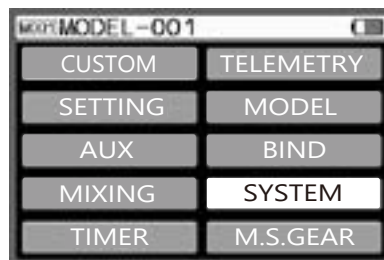

ENTER ↓ ↑ BACK

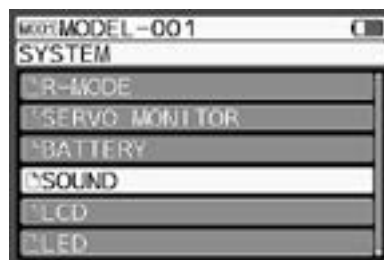

ENTER ↓ ↑ BACK

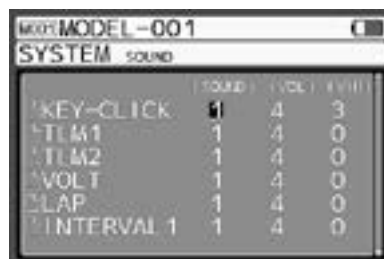

How to use each feature

LCD

SYSTEM

● You can set the brightness (light/ dark) of LCD (liquid crystal) and the light mode of backlight.

1) Select [SYSTEM] using touch pad and decide by Enter operation.

2) Select [LCD] using touch pad and decide by Enter operation.

3) Set the brightness (light/ dark) of LCD (liquid crystal) and the light mode (lighting time) of backlight.

○ Set Items BRIGHT (Brightness of liquid crystal)
 LIGHT-MODE (Backlight light mode)
 LIGHT-TIME (Backlight light time)
 COLOR (Menu Color)

○ Setting Range BRIGHT: 1 ~ 10
 LIGHT-MODE: MOTION/KEY-ON/ALWAYS
 LIGHT-TIME: 1 ~ 30sec
 COLOR: RED-1~5
 PNK-1~5
 PPL-1~5
 DPL-1~5
 IND-1~5
 BLU-1~5
 LBL-1~5
 CYN-1~5
 TEL-1~5
 GRN-1~5
 LGR-1~5
 LIM-1~5
 YEL-1~5
 AMB-1~5
 ORG-1~5
 DOR-1~5
 BRN-1~5
 GRY-1~5
 BGR-1~5

○ Default value BRIGHT: 8
 LIGHT-MODE: KEY-ON
 LIGHT-TIME: 10sec
 COLOR: RED-3

※ [MOTION] of LIGHT-MODE sets the backlight ON by sensing of the motion sensor in-built in the transmitter and key operation.
 [KEY-ON] sets the backlight ON by key operation.
 [ALWAYS] sets the backlight always turn ON.

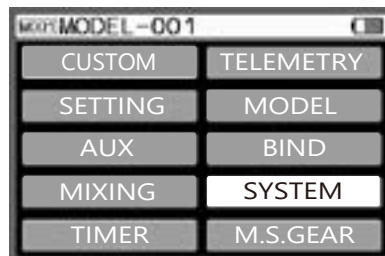

ENTER ↓ ↑ BACK

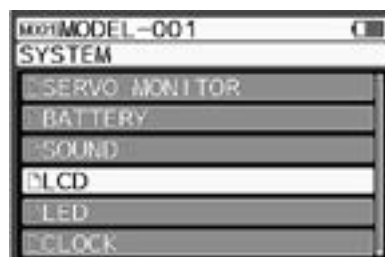

ENTER ↓ ↑ BACK

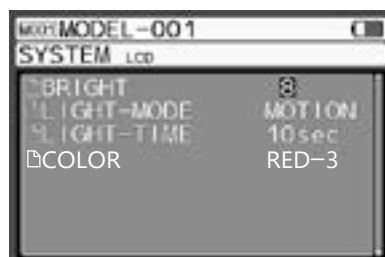

How to use each feature

LED

SYSTEM

● To perform the operation mode of LED and brightness (light/ dark) settings.

- 1) Select [SYSTEM] using touch pad and decide by Enter operation.
- 2) Select [LED] using touch pad and decide by Enter operation.
- 3) Set LED to operation mode and brightness (light/ dark).

- Set Items MODE (Operation mode)
 BRIGHT (LED brightness)
- Setting Range MODE: WAVE/ALWAYS/OFF
 BRIGHT: 1~10
 ※ BRIGHT setting refer to brightness for
 ALWAYS setting
- Default value MODE: WAVE

Function LED

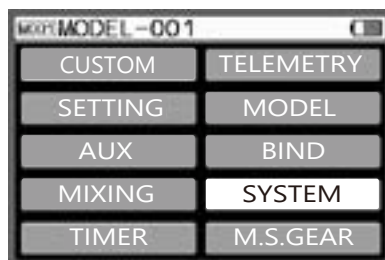
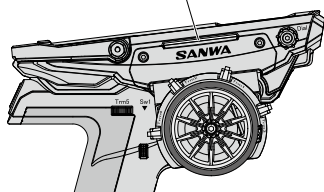

ENTER ↓ ↑ BACK

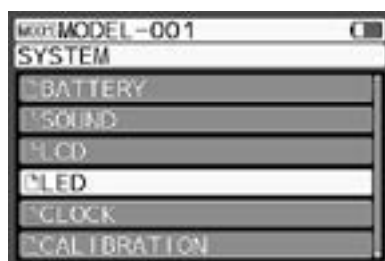

ENTER ↓ ↑ BACK

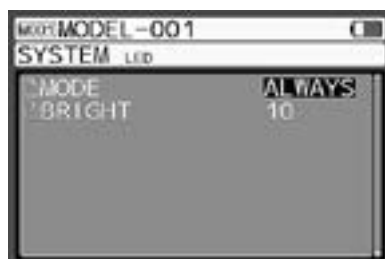

※ Normally, LED emits light according to the settings of LED MODE. However, function LED blinks by synchronising with various functions during operation such as ALB or OFFSET etc or Low battery or telemetry alert.

※ [WAVE] is lighting as waving pattern. [ALWAYS] is to keep turning on the LED or turning off the LED.

※ Even if LED MODE is [OFF], function LED will be blinking when other functions as ALB, OFFSET, Low Battery, or Telemetry Alert is working.

How to use each feature

How to use each feature

CLOCK

SYSTEM

- It is the menu to manage the calendar, clock display and the usage time on the top screen.
- There is [ON TIME1] which is replacement time for battery or the resettable time for charging and [ON TIME 2] which is aims for overhaul of the transmitter.

1) Select [SYSTEM] using touch pad and decide by Enter operation.

2) Select [CLOCK] using touch pad and decide by Enter operation.

3) Set the CLOCK function using touch pad.

The settings for calendar and clock are performed. However, do the settings without fail since the clock settings are needed even for management of log data etc.

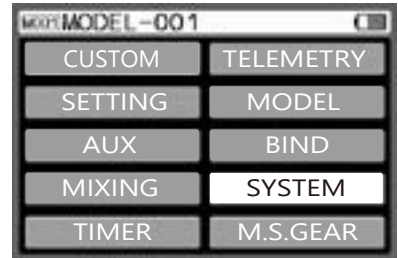

ENTER ↓ ↑ BACK

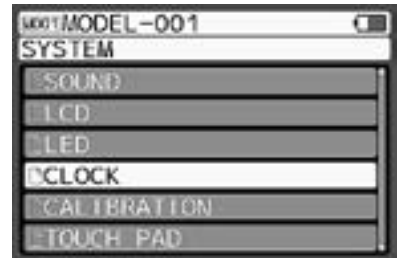

ENTER ↓ ↑ BACK

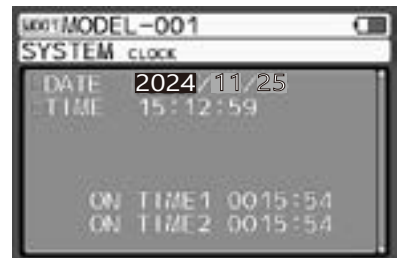

How to use each feature

CALIBRATION

SYSTEM

● In some cases, the neutral position or operation angle might be deviated by wear and tear of internal mechanical parts due to usage time. In such cases, correction of neutral position and operating angle of the steering and throttle can be corrected by calibration.

※ When the rudder angle adjustment function of the steering wheel is used, calibrate the steering wheel without fail.

※ When calibration is carried out, confirm the setting of the neutral position, EPA of all the model memory.

1) Select [SYSTEM] using the touchpad and decide by enter operation.

2) Select [CALIBRATION] using the touchpad and decide by enter operation.

3) Select the channel to be calibrated using the touchpad and decide by enter.

4) When [STEERING] is selected, the steering wheel is fully operated to the left side, right side after the enter operation in the neutral state.

5) Since [OK] is displayed in the numerical width of NEUT/LEFT/RIGHT entered within the correction range, operate according to the screen display.

※ If needed to adjust again, please select [NO] and restart from 4).

6) When calibration is completed, [Executed] will be displayed.

7) If calibration is necessary for the throttle side also, set by referring to calibration of the steering.

Note) Do not set the calibration except in the cases when it is necessary. In some cases, it is not possible to set correctly and operate normally.

Supplement

● Rudder angle adjustment of the steering wheel

Remove the wide steering pad from the steering wheel. The hollow set screw attached to the hexagonal socket supplied in the holes (2 places) of the steering wheel is fixed with screw using a hexagonal wrench driver (1.5 mm) and the angle adjustment is carried out.

(※ Tighten evenly to right and left side).

※ When rudder angle of the steering wheel is adjusted, carry out the calibration without fail.

● If not returned to normal operation even if calibration is carried out, carry out the calibration again and return the setting from [USER] to [FACTORY] of factory shipping. If the problem is still not solved, contact Sanwa Services.

● If the rudder angle of the steering wheel is too narrow, the normal operation might not be possible even if calibration is carried out. Therefore, be careful not to tighten the hollow set screw attached to the hexagonal socket too much.

● To adjust the rudder angle of the steering wheel so that it returns to the initial state, set the hollow set screw attached to the hexagonal socket in a state so that the bis terminal does not come out from the hole of wheel adapter. Carry out the calibration at the time of returning to the initial state also.

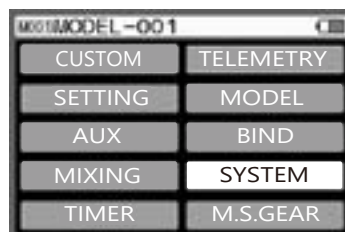

ENTER ↓ ↑ BACK

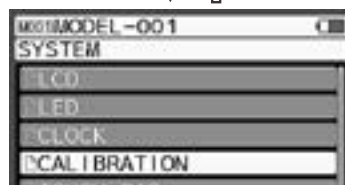

ENTER ↓ ↑ BACK

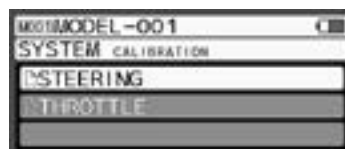

ENTER ↓ ↑ BACK



ENTER ↓ ↑ BACK



ENTER ↓ ↑ BACK

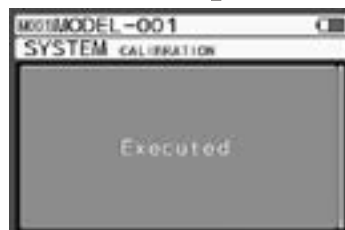

How to use each feature

TOUCH PAD

SYSTEM

● It is a function to adjust the sensitivity (a level that can be sensed by the finger) at the time of operating the touchpad.

● In case of occurrence of any malfunction or in the case when working at a place with high humidity, lower the sensitivity.

When working in low humidity places or when the touchpad does not respond if not pressed hard and when the touchpad does not respond to the operation, increase the sensitivity.

1) Select [SYSTEM] using the touchpad and decide by enter operation.

2) Select [TOUCH PAD] using the touchpad and decide by enter operation.

3) Setting of sensitivity adjustment

Adjust the sensitivity by up/down of the touchpad.

○ Scope of setting : 1 ~ 10

○ Initial value : 5

※ Adjust touchpad operation when turning on the transmitter in each time. In case touching touch pad when turning on the transmitter, touchpad adjustment set the condition for default and touch pad will not work correctly.

※ If increased value for the sensitivity, touch pad sensitivity will be increased. If value is too much high, the touch pad will operate too much.

※ The touchpad has very weak characteristics against moisture and dirt. When the response of the touchpad is bad even after sensitivity adjustment, remove dirt on the touchpad using a wet tissue and wipe the moisture using a dry cloth.

※ Touch Pad setting will not change unless turning OFF the transmitter.

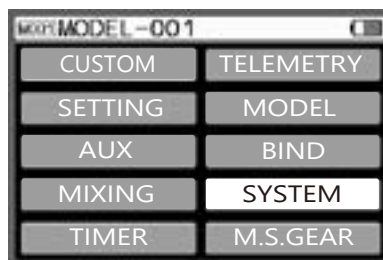

ENTER (Enter) ↓ ↑ BACK (Back)

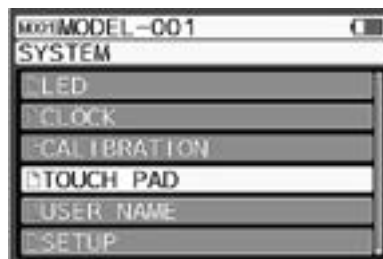

ENTER (Enter) ↓ ↑ BACK (Back)



How to use each feature

USER NAME

SYSTEM

- Username can be registered in the transmitter up to 12 characters such as alphabets, numerical characters, kana, symbols.
- Registered user name is displayed on the opening screen displayed when the power supply is turned on.

1) Select [SYSTEM] using the touchpad and decide by enter operation.

2) Select [USER NAME] using the touchpad and decide by enter operation.

3) Setting of username

Move the cursor to the position by the slide operation or touch operation.

When the position is to be decided, decide the cursor position by enter operation.

4) Enter the username

Enter the characters to be input by touchpad.

When the characters to be input are to be decided, input by enter operation. Select the alphabets/small letters/symbols/katakana by operating the touchpad.

※When the selected character is to be changed or when the cursor on the decided character input position is to be moved, cancel the operation by back operation.

○ Setting scope A ~ Z, a ~ z, 0 ~ 9, Japanese characters, Japanese characters (small katakana), symbols, space

5) When you finish entering characters, tap on [CHANGE] next to the user name to save the new user name.



ENTER ↓ ↑ BACK

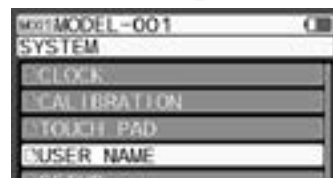

ENTER ↓ ↑ BACK

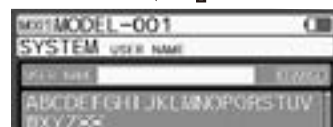

ENTER ↓ ↑ BACK

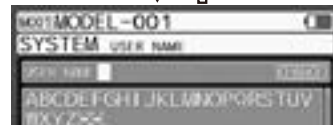

Character select cursor

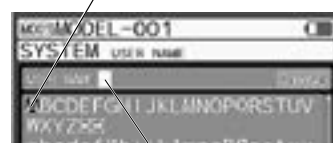

Character position cursor

↓ Back Operation after select characters

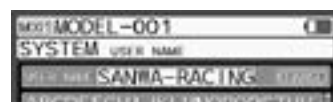

↓ Down Operation

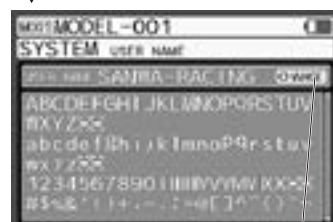

Click [CHANGE] after completing the character input

How to use each feature

How to use each feature

SETUP

SYSTEM

● In Setup, a unit of temperature display of telemetry data, settings such as display settings of the opening logo when the power switch is set ON, operation settings when rearranged to resume setting, left-handedness, username settings are carried out.

1) Select [SYSTEM] using the touchpad and decide by Enter operation.

2) Select [SETUP] using the touchpad and decide by Enter operation.

3) Select the items to be set using the touchpad and do the adjustment.

○ Set Items

UNIT (Temperature unit of telemetry data): ° C/° F

BOOT (Opening logo when the power supply is ON): DEMO/NONE

RESUME (Resume): OFF/ON

HANDEDNESS (Switching left/right): RIGHT/LEFT

NO OPE WARN (No operation alarm): OFF/1 ~ 30min

AUTO OFF: OFF/5 ~ 10min

○ Default Settings

UNIT : °C

BOOT : DEMO

RESUME : OFF

HANDEDNES : RIGHT

NO OPE WARN : 10min

AUTO OFF : OFF

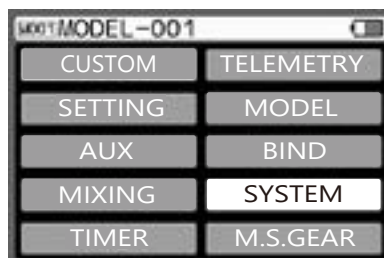

ENTER ↓ ↑ BACK

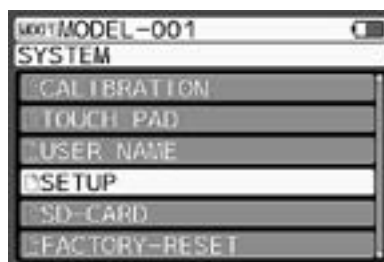

ENTER ↓ ↑ BACK

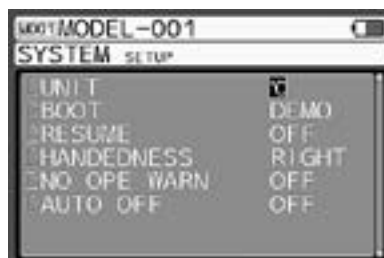

※ When RESUME is set ON, the menu at the time of turning OFF the power supply is stored.

※ AUTO OFF function is transmitter will be automatically turned OFF when setting time for NO OPE WARM (No Operation alert) continue to operate.

How to use each feature

SD CARD

SYSTEM

● Carry out version confirmation and updating of firmware mounted on the transmitter, confirmation of language file, management of the voice data used by the read-aloud function.

- 1) Select [SYSTEM] using touchpad and decide by enter operation.
- 2) Select [SD CARD] using touchpad and decide by enter operation.
- 3) Select the items to be set by touchpad and then set.

○ Set items

FIRMWARE (Firmware): Verify transmitter firmware version and update it.

LANGUAGE (Language file): Manage language files.

VOICE DATA (Voice data): Manage voice data.

4) When updating the firmware, language file or voice data, download the data file from our company homepage into the micro SD card and insert it in the transmitter.

※ About firmware update

• Download the latest firmware form Sanwa home page to the micro SD card. Insert it into micro SD slot of M17S.

• When you enter [UPDATE] on the firmware confirmation screen, it will switch to the update confirmation screen. Follow the message displayed on the screen to update.

※ The procedure to update LANGUAGE and VOICE DATA is same as FIRMWARE, please follow the message displayed on the screen.

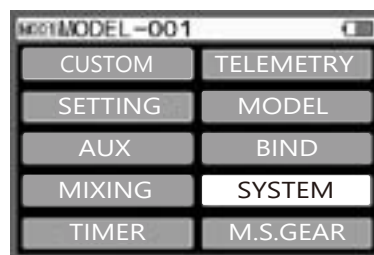

ENTER ↓ ↑ BACK

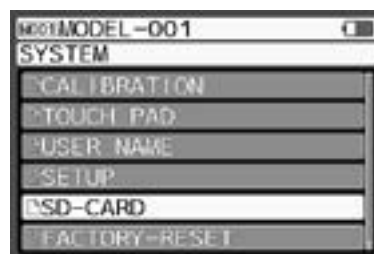

ENTER ↓ ↑ BACK



① Firmware select by enter operation

ENTER ↓ ↑ BACK

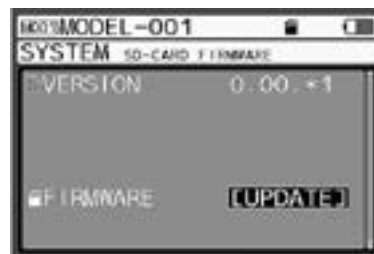

② Current firmware version is displayed on screen
※ Insert SD card before updating

ENTER ↓ ↑ BACK

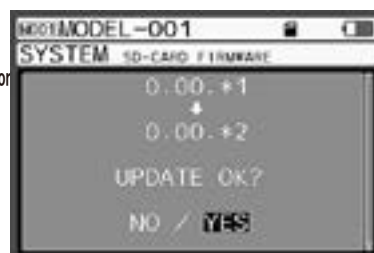

③ Update confirmation screen

←
ENTER

④ Update execution



•NO → Return to ②
•YES→ ④ Update execution

[Back to INDEX](#)

How to use each feature

FACTORY -RESET

SYSTEM

● Reset to factory state by clearing all settings of model data and setting of key assignment etc.

1) Select [SYSTEM] using touchpad and decide by enter operation.

2) Select [FACTORY-RESET] using touchpad and decide by enter operation.

3) When you perform the enter operation, a message will be displayed on the screen, please follow the message displayed to reset.

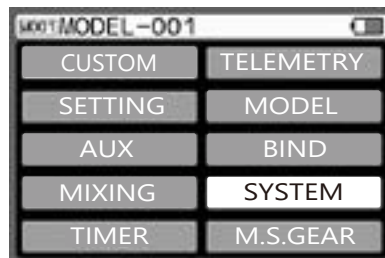

ENTER ↓ ↑ BACK

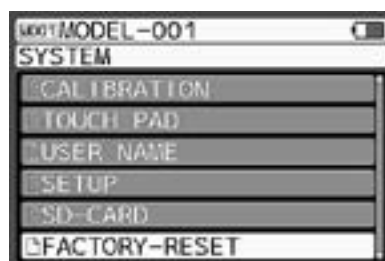

ENTER ↓ ↑ BACK



①Confirmation screen

- NO →FACTORY RESET selection screen
- YES→Factory reset execution ②

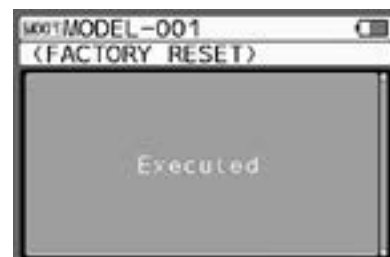

②Executing reset



Warning

● Please be aware that all model data will be erased when performing Factory Reset. As a precaution we recommend that you save the model data on an SD card before performing a factory reset.

MULTI SETTING GEAR

Multi Setting Gear

● PGS servos can connect to servo port and set program by the Multi Setting Gear function.

1) Please connect PGS servos to the servo port, and tap enter "M.S. GEAR" on menu.

*Take care of direction of connecting port when connecting to servo port.

* Without servo connection, display "Please connect device."

Servo port

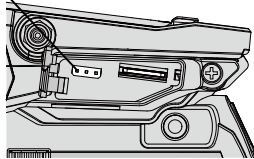

2) After tap enter, show "Read OK?" on the screen, and tap "YES" and start "Device read."

3) If correctly connected servo, move to "View and Edit" mode (P.25).

* if incorrectly connected servos or choose "No", move to top menu.

*If using lead harness (extension cable) please use 1 lead harness.

*Do not take off PGS Servo while setting the servo. Setting value is not complete until "Write" setting value.

*Do not take off PGS Servo while writing the value. It is possible to be broken servo firmware.

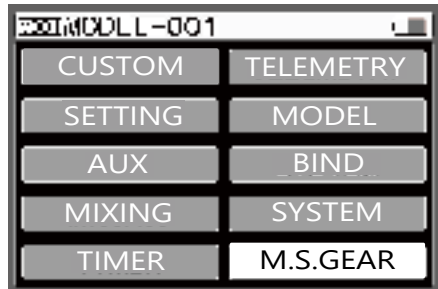

ENTER ↓ ↑ BACK

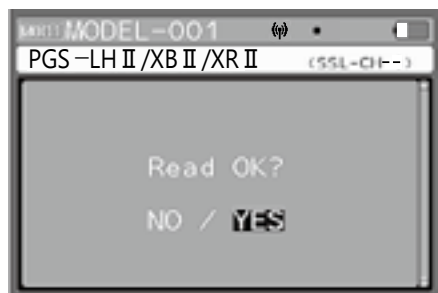

If not connecting servo, display the below message



PGS-LH II /XB II /XR II connected

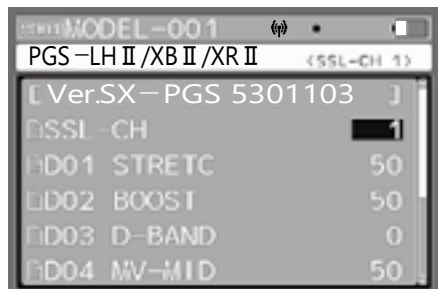

MULTI SETTING GEAR

● Multi Setting Gear Function Menu

Multi Setting Gear function is 4 main menu: Setting Data, Telemetry & Code, Program Update, and Information.

1. SETTING DATA: set current connected servo contents
2. TELEMETRY & CODE: customize telemetry & code setting
3. PROGRAM UPDATE: update PGS servo firmware from file from SD card
4. INFORMATION: check current connected PGS servo firmware version

Setting Data

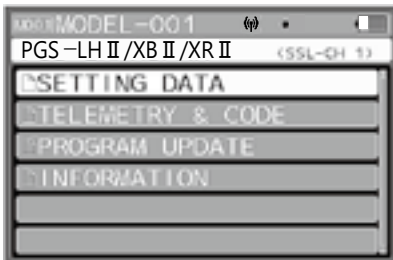

Program Update

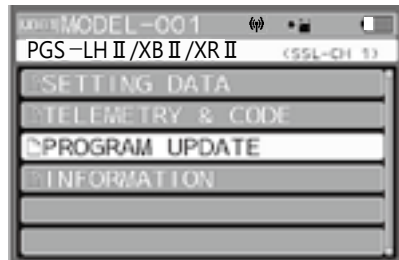

Telemetry & Code

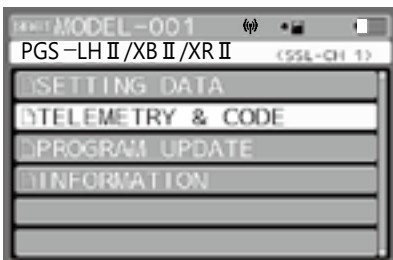

Information

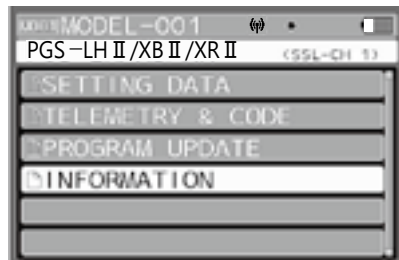

MULTI SETTING GEAR

[SETTING DATA]

Setting data have 6 contents for compatible servos in the below.

*Setting data can be set, read, and write servo setting values.

1. READ

Read connected servos data

2. LOAD (SD)

Load setting data from Micro SD card (if data for PGS servos were saved)

*Load cannot work without micro SD card.

*Servo setting did not change until finished "WRITE."

3. VIEW & EDIT

Check setting values and change servo settings.

4. WRITE

Write servo settings to connected servos.

*Servo setting did not change until finished "WRITE."

5. SAVE (SD)

Save current setting values to Micro SD card.

File name of each servo

PGS-LH/XB/XR: P51**S00 - P51**S49

PGS-CL/CX: P52**S00 - P52**S49

PGS-LH II/XB II/XR II: P53**S00 - P53**S49

PGS-CL II/CX II: P54**S00 - P54**S49

PGS-HR/HX: P55**S00 - P55**S49

PGS-CLEI: P56**S00 - P56**S49

SGS-02: P57**S00 - P57**S49

*Please do not change file name by using computer.

The file could not be used on M17S.

6. DATA FACTRY CLEAR

Reset connected servos setting data to factory setting (default setting).

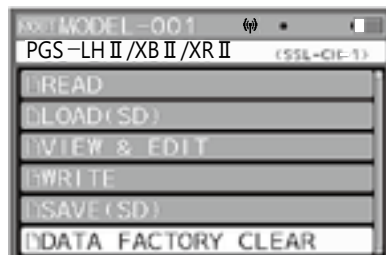
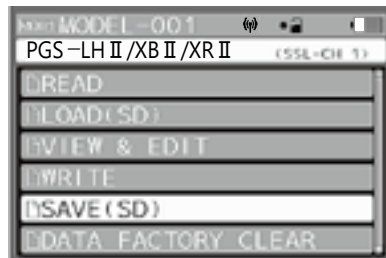
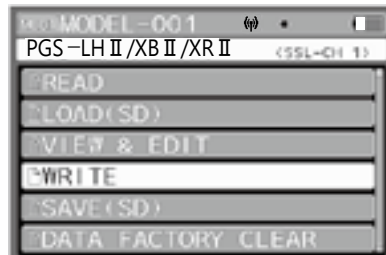
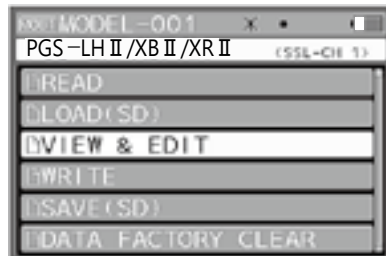
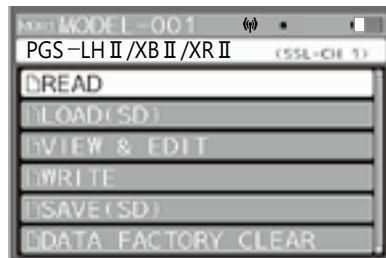

MULTI SETTING GEAR

● About setting change

1. SSL-CH: SSL channel can be changed.

Setting range: 0-4, 11-20

If SSL-CH set up [0], SSL operation will be turned off.

SSL-CH default setting is [1]. PGS Servo will be operated as steering (ST) when PGS servo connects to SSL port at receiver. Please set SSL-CH is [2] in case of using for throttle.

SSL-CH Setting

CH Setting	Value	CH Setting	Value
CH OFF	0	AUX1CODE01	11
CH1 [ST]	1	AUX1CODE02	12
CH2 [TH]	2	AUX1CODE03	13
CH3	3	AUX1CODE04	14
CH4	4	AUX1CODE05	15
		AUX1CODE06	16
		AUX1CODE07	17
		AUX1CODE08	18
		AUX1CODE09	19
		AUX1CODE10	20

2. D01 STRETC (Stretcher)

Servo holding force can be set by the stretcher. If the value sets high, torque handling force is increased. If sets the value near [100], it will be caused to hunting near neutral but it is depends on other setting. Setting range: 0-100

3. D02 BOOST

Initial torque power can be set by boost. If value sets high, the initial stage torque is increased. If value sets too high, it would be haunting. Setting range: 0-100

4. D03 D-Band (Dead-Band)

Dead zone range when servo starts moving. If the value sets low, the dead zone range is narrow. If value sets too low, it would be caused to haunting.

Setting range: 0 ~ 100

5. D04 MV-MID

MV-MID is torque adjustment in middle range during operation. In case of steering, the function adjusts mid-range torque during cornering. If the value sets high, the function becomes more effective.

Setting range: 0 ~ 100

6. D05 MV-END

MV-END is torque adjustment in end range during operation. In case of steering, the function adjusts end-range torque during cornering. If the value sets high, the function becomes more effective.

Setting range: 0 ~ 100



ENTER ↓ ↑ BACK

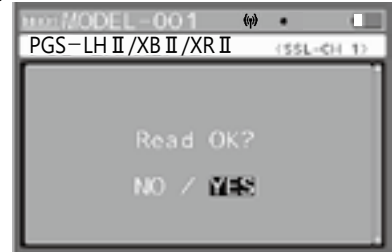

Select [YES] ↓ ENTER

Change setting values on each function

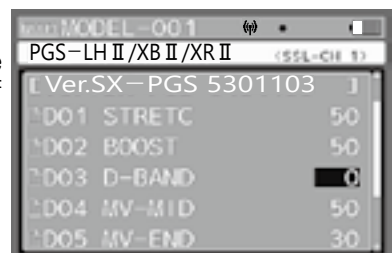
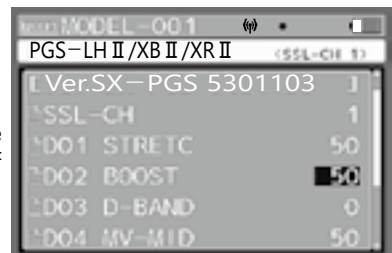
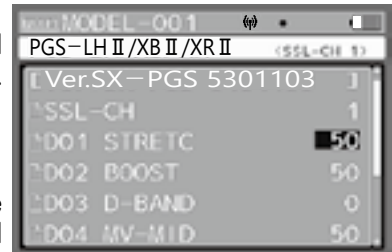
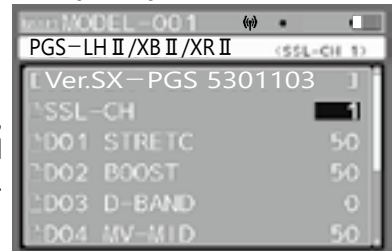

MULTI SETTING GEAR

7. D06 BRAKE

Set brake when stop the operation. If the value sets high, the brake is stronger and it is easy to stop at object point. If the value sets too high, operation speed becomes slow.
Setting range: 0 ~ 100

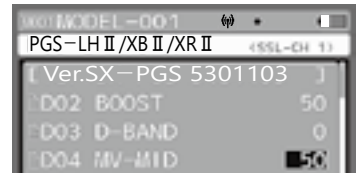

8. D07 MV-HLD (MV Hold): MV-HLD is torque adjustment from middle range to end-range. Set torque varying lengths of time from middle range to end range. If the value sets high, the torque varying lengths of time becomes long.
Setting range: 0 ~ 100

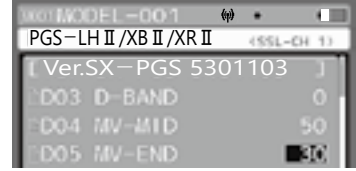

9. D08 MV-FRQ (MV Frequency)

MV-FRQ is drive frequency adjustment. Set output signal frequency for motor control. If the value sets high, control response for external force becomes fast.
Setting range: 0 ~ 100

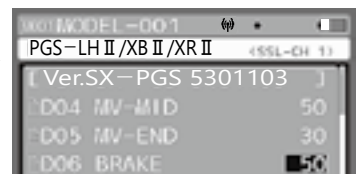

10. D09 MAX-PW (MAX Power)

Set maximum power of torque in all range. If the value sets high, the power is increased.
Setting range: 0 ~ 100

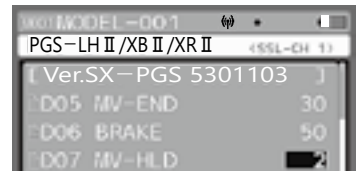

11. WRITE TO DEVICE

Please choose Enter after set each setting value, and display will be “Write OK?”
Then, tap “Yes” to write setting value to PGS servos.

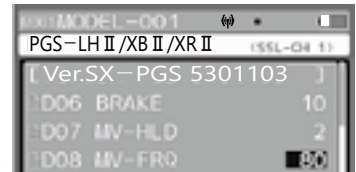

*DO NOT turn off transmitter or disconnect servo during the writing. It will be caused servo firmware broken.

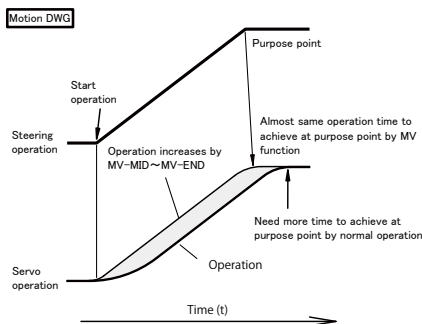
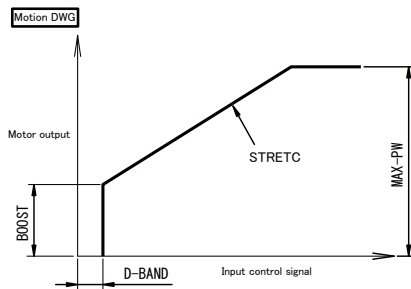
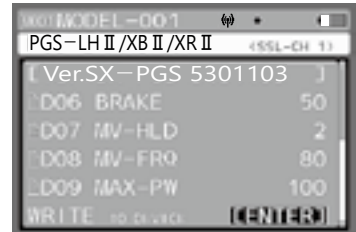
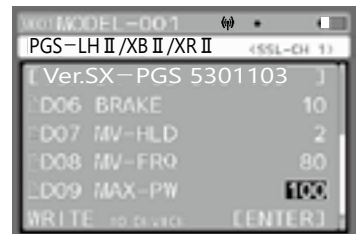

MULTI SETTING GEAR

[TELEMETRY & CODE]

Telemetry & Code menu is for telemetry and code assign setting. It is able to switch telemetry data on transmitter display. It is also able to switch, turn on and off functions to adjust in AUX CODE. Please insert Micro SD Card to use the functions.

[Telemetry Setting]

Telemetry data on transmitter are 3 functions: (T00) TLM1, (T01) TLM2, and (T05) VOLT

Telemetry information on the display can set channel and contents by [R] (return) value.

Default setting is no telemetry setting.

[T00 TLM1/T01 TLM2 and T05 VOLT]

T00 - T05 can be set the below contents.

- [00] OFF [01] Servo Current Value [03] Amount of Operation
- [04] Amount of Operation & Effect [05] Amount of Servo Operation
- [05] Motor Output [06] CPU Temperature [07] Power Current Voltage

* In case PGS servo telemetry data is displayed with using SUPER VORTEX Gen2 PRO/Gen2/SV-D2, Telemetry display will be duplicated with the ESC. In case PGS servo telemetry is displayed, please connect the ESC to receiver CH2.

* In case telemetry display setting is [00], display function is OFF. (PGS servo default setting is [00].)

[CODE AUX Setting]

CODE AUX Setting can be change CODE10 function contents from transmitter on CODE AUX 2.

- A2-CD1 (AUX2 CODE01)- [SSL-CH] (SSL-Channel) set as the default setting.
- A2-CD2 (AUX2 CODE02)- [STRETC] (Stretcher) set as the default setting.
- A2-CD3 (AUX2 CODE03)-[BOOST] set as the default setting.
- A2-CD4 (AUX2 CODE04)-[D-BAND] (Dead band) set as the default setting.
- A2-CD5 (AUX2 CODE05)-[MV-MID] set as the default setting.
- A2-CD6 (AUX2 CODE06)- [MV-END] set as the default setting.
- A2-CD7 (AUX2 CODE07)-[BRAKE] set as the default.
- A2-CD8 (AUX2 CODE08)- No setting as the default.
- A2-CD9 (AUX2 CODE09)- No setting as the default.
- A2-CD10(AUX2 CODE10)- No setting as the default.

※ Please, do not set same function to several CODEs not to be into the trouble.

WRITE TO DEVICE: Please choose Enter after set each setting value, and display will be "Write OK?"

Then, tap "Yes" to write setting value to cunnected servos.

*Setting change will not apply until writting the setting value to connected servo.

* A2-CD1 can be set only [SSL-CH].

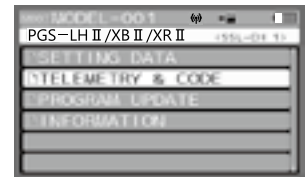

ENTER ↓

Select setting function

SSL-CH SETTING [R] RETURN SETTING

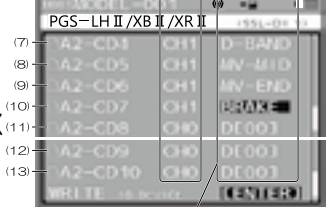
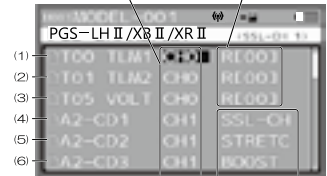

CODE AUX SETTING

T00 TLM1, T01, TLM2, T05 VOLT setting

Telemetry Display Function [R]	Setting Value
Off Function	00
Servo current values	01
Amount of operation	02
Amount of input operation + effect	03
Amount of servo operation	04
Motor output	05
CPU temperater	06
Power current voltages	07

*T00 TLM1, T01 TLM2 telemetry display function is 07 - 99. Default is OFF.

*T05 VOLT telemetry display function [R] setting is OFF except T07.

*Please set AUX type is CODE 10 for use.

CODE AUX settings Contents
SSL-CH (SSL Channel)
STRETC (Stretcher)
BOOST
D-BAND (Dead band)
MV-MID
MV-END
BRAKE
MV-HLD (MV-Hold)
MV-FRQ (MV-Frequency)
MAX-PW (MAX-Power)

How to use each feature

MOTION STEERING

- Motion steering can operate steering by transmitter angle.

It assigned [SW3] as motion steering and do calibration can work motion steering by transmitter angle.

When turning on SW3, motion steering can be worked.

When turning off SW3, wheel steering can be worked (motion steering will be off).

*It can not work wheel steering and motion steering simultaneously.

- 1) Select [SYSTEM] and decide by enter operation.
- 2) Select [KEY ASSIGN] and decide by enter operation.

3) SW3 Setting

Select [MOTION] and decide by enter operation.

*Function setting will be locked and cannot change setting during motion steering (SW3) is on.

4) SW3 setting

Select mode setting and then set.

Setting Range: VIB+BZ/BUZZER/VB/OFF

Default: VIB+BZ

5) Motion Steering Calibration Setting

Select [SYSTEM] and decide by enter operation.

*Before calibration, please check [SW3] is on.

- 6) Select [STEERING] and decide by enter operation.

Change [FACTRY] to [USER] of [SETTING] and do calibration.

- 7) Keep M17S vertical position on the desk, and enter for [NEUT].

NEUT [0] OK will be displayed as setting center position.

After that, grab the M17S and tilt M17S left side and right side.

*Both left side and right side maximum position is horizontal line.

- 8) When completed calibration, [OK] will be displayed side of NEUT/

LEFT/RIGHT. If it is no problem, select [YES] and enter to finish calibration setting.

In case of resetting calibration, select [NO], and back to 7).

*While using motion steering, please adjust car right and left amount of movement by steering EPA setting. Also, use and adjust with EXP or ARC function.

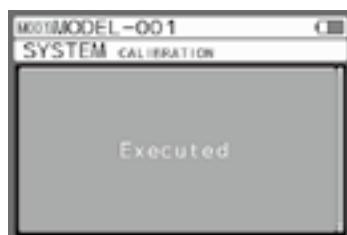
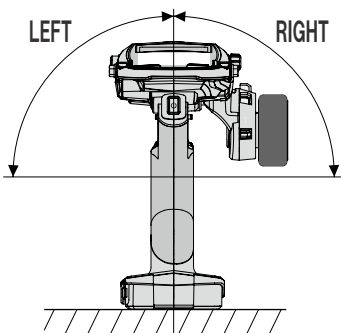

← ENTER

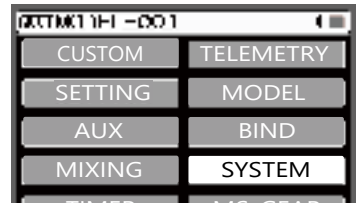

ENTER ↓ ↑ BACK



ENTER ↓ ↑ BACK

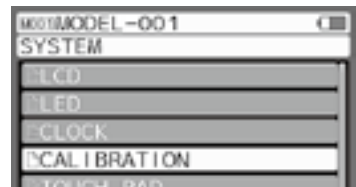
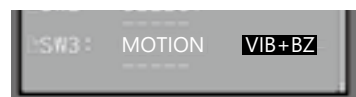
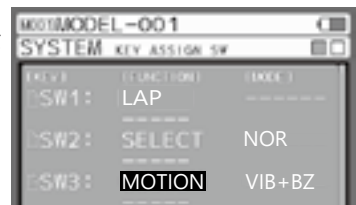

ENTER ↓ ↑ BACK

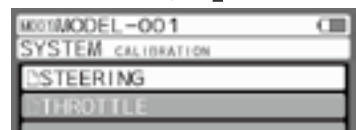

ENTER ↓ ↑ BACK

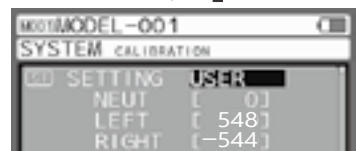

ENTER ↓ ↑ BACK

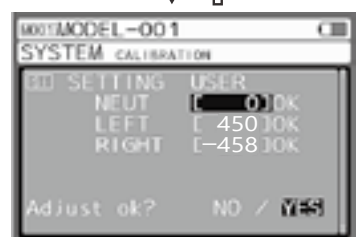

SERVICE AND SUPPORT

PROBLEM	POSSIBLE CAUSE	SOLUTION
Transmitter does not power on.	Battery voltage too low.	Please charge the battery.
Sometimes power off unexpectedly.	Battery connector bad contact.	Please contact Sanwa service.
Alarm sound continuously.	Battery connector bad contact.	Please charge the battery.
There is no sound when operating one of the keys.	The KEY-CLICK volume is set to OFF (0) in SOUND setting.	Please check the SOUND function.
Servo speed is slow.	The setting is negative with SPEED (speed) function.	Please check the SPEED (speed) function.
	Receiver battery voltage is too low.	Please charge or replace with a charged battery.
	The loading on the servo linkage in the car is too high.	Please check servo linkage in the car is smooth.
Lap timer or interval timer does not work.	The timer function is OFF.	Turn on the timer function.
The left and right travel angle of servo does not match.	Neutral position of servo is not adjusted properly.	Please adjust the Trim and EPA.
The servo linkage bind.	D/R or EPA travel angle setting is too high.	Please adjust setting value to 100% or lower.
Servo does not move when using Trim Switch.	Trim is outside of operational range.	Center Trim Switches to '0', center the servo horn and control linkages.
Inadequate transmitting range.	Low transmitter battery voltage.	Replace or recharge transmitter battery.
	Low receiver battery voltage.	Replace or recharge receiver batteries.
	Receiver antenna not mounted correctly.	Mount receiver antenna as recommended.

Assign Function List (TRIM)

Screen	Function name
OFF	--- (No Function Assigned)
TRIM-ST	Steering Trim
TRIM-TH	Throttle Trim
TRIM-A1	AUX1 Trim
TRIM-A2	AUX2 Trim
D/R-ST	Steering Dual Rate
D/R-TH	Throttle Dual Rate
D/R-BR	Brake Dual Rate
D/R-A1H	AUX 1 Hi Dual Rate
D/R-A1L	AUX 1 Lo Dual Rate
D/R-A2H	AUX 2 Hi Dual Rate
SPD-ST-FWD	Steering Speed Forward
SPD-ST-RTN	Steering Speed Return
SPD-ST-PNT	Steering Speed Point
SPD-TH-FWD	Throttle Speed Forward
SPD-TH-RTN	Throttle Speed Return
SPD-TH-PNT	Throttle Speed Point
SPD-A1-FWD	AUX 1 Speed Forward
SPD-A1-RTN	AUX 1 Speed Return
SPD-A1-PNT	AUX 1 Speed Point
SPD-A2-FWD	AUX 2 Speed Forward
SPD-A2-RTN	AUX 2 Speed Return
SPD-A2-PNT	AUX 2 Speed Point
CRV-ST-RATE	Steering Curve Rate
CRV-ST-PNT	Steering Curve Point
CRV-TH-RATE	Throttle Curve Rate
CRV-TH-PNT	Throttle Curve Point
CRV-BR-RATE	Brake Curve Rate
CRV-BR-PNT	Brake Curve Point
CRV-A1(H)-RATE	AUX 1(H) Curve Rate
CRV-A1(H)-PNT	AUX 1(H) Curve Point
CRV-A1(L)-RATE	AUX 1(L) Curve Rate
CRV-A1(L)-PNT	AUX 1(L) Curve Point
CRV-A2(H)-RATE	AUX 2(H) Curve Rate
CRV-A2(H)-PNT	AUX 2(H) Curve Point
CRV-A2(L)-RATE	AUX 2(L) Curve Rate
CRV-A2(L)-PNT	AUX 2(L) Curve Point
ALB-POINT	Anti Lock Brake Point
ALB-STROKE	Anti Lock Brake Stroke
ALB-LAG	Anti Lock Brake Lag
ALB-CYCLE	Anti Lock Brake Cycle
ALB-DUTY	Anti Lock Brake Duty
OFFSET-PNT	Offset Point
CM1-RATE1	Compensation Mixinging 1 Rate 1
CM1-RATE2	Compensation Mixinging 1 Rate 2
CM1-OFFSET	Compensation Mixinging 1 Offset
CM2-RATE1	Compensation Mixinging 2 Rate 1
CM2-RATE2	Compensation Mixinging 2 Rate 2
CM2-OFFSET	Compensation Mixinging 2 Offset
CM3-RATE1	Compensation Mixinging 3 Rate 1
CM3-RATE2	Compensation Mixinging 3 Rate 2
CM3-OFFSET	Compensation Mixinging 3 Offset
CM4-RATE1	Compensation Mixinging 4 Rate 1
CM4-RATE2	Compensation Mixinging 4 Rate 4
CM4-OFFSET	Compensation Mixinging 4 Offset
CM5-RATE1	Compensation Mixinging 5 Rate 1
CM5-RATE2	Compensation Mixinging 5 Rate 2
CM5-OFFSET	Compensation Mixinging 5 Offset

Screen	Function name
AUX1	AUX1
AUX2	AUX2
AUX1-ACKER	AUX 1 Ackerman
AUX1-D/R	AUX 1 Ackerman Dual Rate
AUX1-LEFT	AUX 1 Ackerman Left
AUX1-RIGHT	AUX 1 Ackerman Right
AUX1-CENT	AUX 1 Ackerman Center
AUX1-TOE	AUX 1 Ackerman Toe
AUX2-ACKER	AUX 2 Ackerman
AUX2-D/R	AUX 2 Ackerman Dual Rate
AUX2-LEFT	AUX 2 Ackerman Left
AUX2-RIGHT	AUX 2 Ackerman Right
AUX2-CENT	AUX 2 Ackerman Center
AUX2-TOE	AUX 2 Ackerman Toe
AUX1-FLAP	AUX 1 Flap
AUX1-TH-FL	AUX 1 Throttle Flap
AUX2-FLAP	AUX 2 Flap
AUX2-TH-FL	AUX 2 Throttle Flap
AUX1-CODE1	AUX 1 Code 1
AUX1-CODE2	AUX 1 Code 2
AUX1-CODE3	AUX 1 Code 3
AUX1-CODE4	AUX 1 Code 4
AUX1-CODE5	AUX 1 Code 5
AUX1-CODE6	AUX 1 Code 6
AUX1-CODE7	AUX 1 Code 7
AUX1-CODE8	AUX 1 Code 8
AUX1-CODE9	AUX 1 Code 9
AUX1-CODE10	AUX 1 Code 10
AUX2-CODE1	AUX 2 Code 1
AUX2-CODE2	AUX 2 Code 2
AUX2-CODE3	AUX 2 Code 3
AUX2-CODE4	AUX 2 Code 4
AUX2-CODE5	AUX 2 Code 5
AUX2-CODE6	AUX 2 Code 6
AUX2-CODE7	AUX 2 Code 7
AUX2-CODE8	AUX 2 Code 8
AUX2-CODE9	AUX 2 Code 9
AUX2-CODE10	AUX 2 Code 10
R-MODE	Racing Mode
ALB-SW	Anti Lock Brake Switch
OFFSET-SW	Offset Switch
CM1-SW	Compensation Mixing 1 Switch
CM2-SW	Compensation Mixing 2 Switch
CM3-SW	Compensation Mixing 3 Switch
CM4-SW	Compensation Mixing 4 Switch
CM5-SW	Compensation Mixing 5 Switch
LAP-SW	Lap Timing Switch
INT1-SW	Interval Time 1 Switch
INT2-SW	Interval Time 2 Switch
DOWN-SW	Down Timing Switch
CUSTOM	Custom
VOICE-REQ	Voice Request
CURSOR	Cursor
ENTER/BACK	Enter / Back
SELECT	Select
INC/DEC	Increase / Decrease (Plus / Minus)

How to use each feature

Assign Function List (TRIM)

Screen	Function Name	SW1/SW2	SW3
OFF	--- (No Function Assigned)	○	○
ALB	Anti Lock Brake	○	○
OFFSET	OFFSET	○	○
AUX1 [STEP]	AUX1 Step	○	○
AUX1 [POINT]	AUX1 Point	○	○
AUX1 [4WS]	AUX1 4 Wheel Steering	○	○
AUX1 [MOA]	AUX1 Motor On Axle	○	○
AUX1 [D-ST]	AUX1 Dual Steering	○	○
AUX1 [BR]	AUX1 Brake Mixing	○	○
AUX1 [BOAT]	AUX1 Boat	○	○
AUX1 [CD5]	AUX1 CODE5	○	○
AUX1 [CD10]	AUX1 CODE10	○	○
AUX2 [STEP]	AUX2 Step	○	○
AUX2 [POINT]	AUX2 Point	○	○
AUX2 [4WS]	AUX2 4 Wheel Steering	○	○
AUX2 [MOA]	AUX2 Motor On Axle	○	○
AUX2 [D-ST]	AUX2 Dual Steering	○	○
AUX2 [BR]	AUX2 Brake Mixing	○	○
AUX2 [CD5]	AUX2 CODE5	○	○
AUX2 [CD10]	AUX2 CODE10	○	○
INT1	Interval Timer1	○	○
INT2	Interval Timer2	○	○
DOWN	Down Timer	○	○
C-MIX	Compensation Mixing	○	○
C-MIX1	Compensation Mixing1	○	○
C-MIX2	Compensation Mixing2	○	○
C-MIX3	Compensation Mixing3	○	○
C-MIX4	Compensation Mixing4	○	○
C-MIX5	Compensation Mixing5	○	○
VOICE	VOICE	○	
SELECT	SELECT	○	
CUSTOM	CUSTOM	○	○
R-MODE	Racing Mode	○	
KEY LOCK	KEY LOCK		○
ALT	Alternate		○
MOTION	Motion		○

How to use
each feature