

1:16 4WD ELECTRIC MONSTER TRUCK



ABSIMA

BEDIENUNGSANLEITUNG / MANUAL MODE D'EMPLOI



RTR







ABSIMA

FIRST STEP PERFORMANCE



 Entdecke Deine Modellsport Seele mit der packenden „First Step Performance“ von Absima. Über 36 KM/H und Power satt gilt es bei dieser Serie zu bändigen. Unterstützt wirst Du dabei natürlich von echter Modelltechnik. Neben einer sicheren 2.4 GHz Fernsteueranlage gibt ein 50A Fahrtenregler die Kraft frei. Klein, Fein und Gemein-Schnell - mach den „First Step“ in die RC Modellsport Welt mit diesem RTR Set.

 Discover RC model sport with the "First Step Performance" from Absima. More than 36 KM/H and power to the max you will get with this awesome model. Of course you will be supported by real RC model technique. A safe 2.4 GHz remote control system supports the 50A electronic speed controller to release the power at your command. Small, fine, and mean! Take the first step into the world of RC model sport with this ready-to-run set.

 Découvrez le sport de modélisme RC avec le "First Step Performance" d'Absima. Plus de 36 KM/H et puissance au maximum que vous obtiendrez avec ce modèle génial. Bien sûr, vous serez assisté par une véritable technique de modèle RC. Un 2,4 GHz sûr Le système de télécommande prend en charge le contrôleur de vitesse électronique 50 A pour libérer la puissance à votre commande. Petit, bien, et méchant ! Faites le premier pas dans le monde du sport modélisme RC avec cet ensemble prêt à l'emploi.

RTR 2.4GHz READY TO RUN RADIO SYSTEM

REMOTE CONTROL CAR

-  Steering Trim
-  Throttle trim (low speed to high speed)
-  Power Switch

- > Brushed DC electric motor
- > Speed: Up to 36+km/h
- > Scale 1:16
- > Up to 60m remote range
- > Operation time: up to 15 min.
- > Rubber tires
- > Sealed ball bearings
- > Four wheel independent
- > Suspension system
- > Frequency: 2.4 GHz
- > Stuck protection
- > Charging pressure limiting protection
- > Over-discharge protection
- > Car battery: 1,500mAh included
- > Remote control power supply: 3x1.5V "AA" (R6) batteries (Not included)
- > Suitable for children above 14 years old



Item 16007



Item 16008



Item 16020



Item 16021



ELECTRONIC SPEED CONTROL REMOTE CONTROL DISTANCE OF 60M

RECEIVER WITH
ELECTRONIC SPEED
CONTROLLER

FULL-VEHICLE
TRANSMISSION
BEARINGS



HIGH-PERFORMANCE MOTOR

RUBBER TIRE



⚠ Vorsicht

Kleinteile! Außerhalb der Reichweite von Kindern aufbewahren!
Betreiben Sie ihr Fahrzeug nur auf offenem, gut einsehbarem Gelände
Bei schwacher Senderleistung das Fahrzeug sofort stoppen und Batterien ersetzen
Bitte bewahren Sie das Fahrzeug in einer trockenen und kühlen Umgebung auf
Halten Sie das Fahrzeug von Feuer, heißer oder feuchter Umgebung fern
Achten Sie darauf, dass das Fahrzeug und die Batterie immer trocken sind um Schäden zu vermeiden

Produkt Konfiguration



1. Entfernen der Karosserie

Entfernen Sie die Splinte und nehmen Sie die Karosserie ab

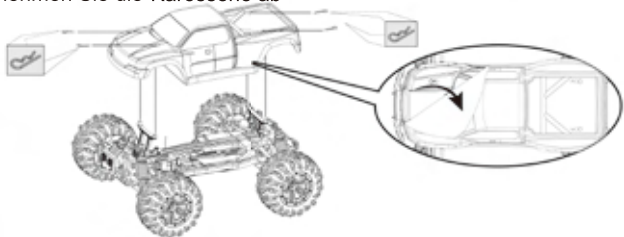

Stellen Sie sicher, dass alle Zubehörteile richtig angebracht sind. Entfernen Sie vorher den Schutzfilm von der Karosserie.

3. Installieren Sie die Senderbatterien

(1) Entfernen Sie die Batterieabdeckung. (Abb.1)
(2) Installieren Sie 3x 1.5V AA Batterien (nicht im Lieferumfang enthalten) (Abb.2) und (3) schließen Sie die Abdeckung. (Abb.3)

ACHTUNG!

Achten Sie auf die richtige Polarität wie angegeben.
Mischen Sie keine alten und neuen Batterien Mischen Sie nicht verschiedene Arten von Batterien

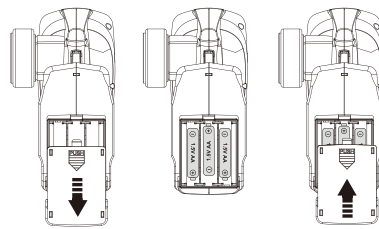

4. Wiederaufladbaren Akku laden und installieren

(1) Stecken Sie das USB-Ladegerät in die Steckdose (Abb. 4) die rote LED leuchtet. Schließen Sie den Akku an das USB-Ladegerät an (Abb. 5) die grüne LED blinkt. Der Ladevorgang ist abgeschlossen, wenn die grüne LED konstant leuchtet.

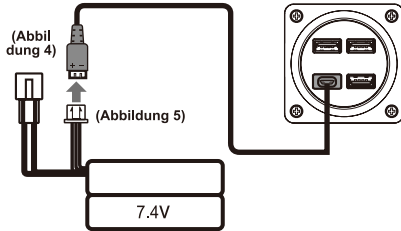

(3) Legen Sie die vollständig geladene Batterie ins Batteriefach und verbinden Sie die Kabel korrekt (Abb. 7)

Power Switch

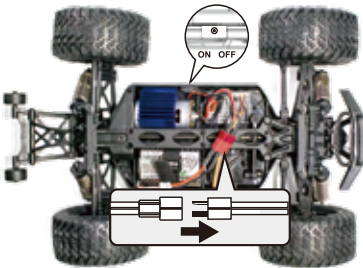

(Abbildung 7)

(2) Lösen Sie das Klettband des Akkus am Gehäuse und nehmen Sie ihn dann heraus (Abb. 6)

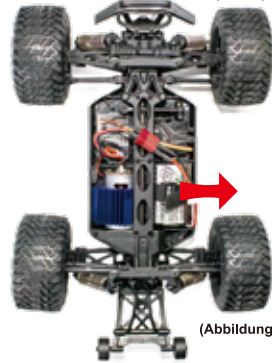

(Abbildung 6)

(4) Setzen Sie den Akku wieder ein und ziehen Sie das Klettband fest (Abb. 8)

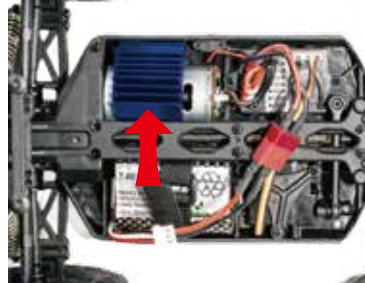

(Abbildung 8)

5. Vorsichtsmaßnahmen beim USB-Ladegerät

! ACHTUNG!

- (1) Verwenden Sie keine Stromquelle für das USB Ladegerät mit mehr als 2.4A
- (2) Ist der Eingangsstrom höher als 2.4A startet automatisch ein Schutzmodus und alle LEDs erlöschen

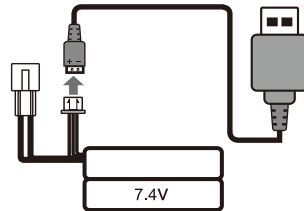

6. Sender Anweisungen



- A. Stromschalter
 B. Lenkung Trim
 C: Gastrimmung
 (niedrige Geschwindigkeit zu hoher Geschwindigkeit)

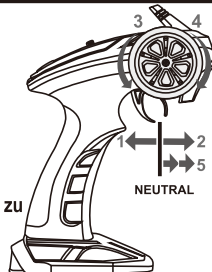

1. Vorwärts
 2. Bremse
 3. Links
 4. Rechts
 5. Zurück



(1) Grüne LED



(2) Rote LED



1. Schalten Sie die Fernsteuerung ein. Die Grüne LED Leuchtet und die rote LED blinkt.
2. Wenn die Verbindung zwischen Auto und Fernsteuerung hergestellt ist, leuchtet die rote LED dauerhaft.

⚠ Blinkt die Grüne LED während des Betriebs, ist die Batterie leer. Bitte austauschen.

7. Anweisungen zum Sender

A. Stromschalter

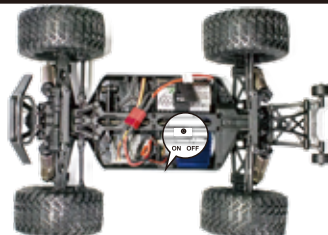
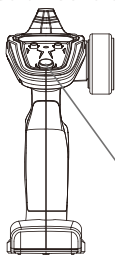

Bei der erstmaligen Paarung müssen sowohl das Auto als auch der Sender innerhalb von 3 Sek. eingeschaltet sein um die Frequenz zu koppeln. Die rote LED am Sender und die LED am Empfänger im Fahrzeug leuchten dauerhaft.

B. Lenkung Trim

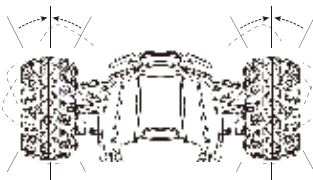
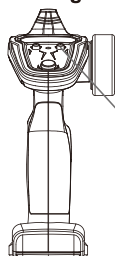

Verwenden Sie ST.TRIM um den Geradeauslauf des Fahrzeugs einzustellen. Fahren Sie dazu langsam von Ihnen weg und drehen Sie am Regler bis das Fahrzeug geradeaus fährt.

C. Gastrimmung

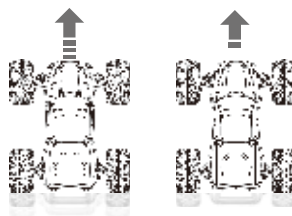
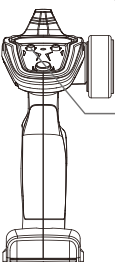

H (Schnelle Geschwindigkeit) **L** (Langsame Geschwindigkeit)

Tipp: Stellen Sie am Anfang die Gastrimmung auf langsam um sich an das Fahrzeug zu gewöhnen



BETRIEB

1. Sc halten Sie immer erst den Sender ein und danach das Fahrzeug. Schalten Sie immer erst das Fahrzeug aus und dann den Empfänger



2. Betreiben Sie ihr Fahrzeug nur auf offenem, gut einsehbarem Gelände.

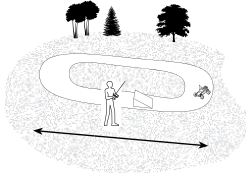

3. **WARNUNG:** Achten Sie darauf das der Wasserstand niedriger als der Boden des Fahrzeugs ist. Wenn Wasser ins Fahrzeuginnere gelangt kann das Schäden hervorrufen, für die Sie selbst verantwortlich sind.



4. Starten Sie immer mit langsamer Fahrt und gewöhnen Sie sich an das Fahrzeug bevor Sie Vollgas geben.

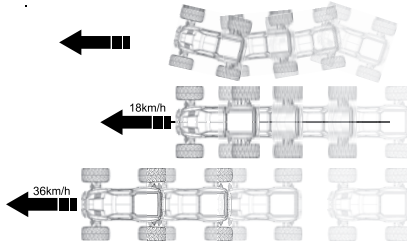
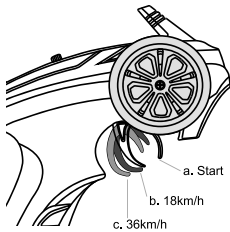

MOTORPFLEGE

- Setzen Sie die Motorbürsten ein, indem Sie während der ersten Akkuladung gleichmäßig auf einer ebenen Fläche fahren. Nicht zu Dies kann die Motorleistung und die Funktionsfähigkeit stark reduzieren.
- Verlängern Sie die Lebensdauer des Motors, indem Sie Überhitzungsbedingungen vorbeugen. Übermäßiger Motorverschleiß resultiert aus häufigen Wenden, Stopps und startet, schiebt Gegenstände, fährt in tiefem Wasser und hohem Gras und fährt kontinuierlich bergauf.

FEHLERBEHEBUNG

Problem	Mögliche Ursache	Lösung
Kurze Laufzeit	<ul style="list-style-type: none"> • Batterie beschädigt / nicht geladen • Motor verschmutzt oder Bürsten abgenutzt 	<ul style="list-style-type: none"> • Batterie prüfen / wechseln • Überprüfen / reinigen / ersetzen
Schleppende Aktion	<ul style="list-style-type: none"> • Motor verschmutzt oder Bürsten abgenutzt • Antrieb einlegen • Fahrzeugbatterie ist nicht geladen 	<ul style="list-style-type: none"> • Überprüfen / reinigen / ersetzen • Reinigen / einstellen • Ersetzen / aufladen
Nicht betätigen	<ul style="list-style-type: none"> • Senderbatterien niedrig • Sender ausgeschaltet • Fahrzeugbatterie ist nicht geladen 	<ul style="list-style-type: none"> • Ersetzen / aufladen • Ein • Ersetzen / aufladen
Schlechte Reichweite	<ul style="list-style-type: none"> • Niedrige Senderbatterien • Empfängerantenne beschädigt 	<ul style="list-style-type: none"> • Ersetzen / aufladen • Überprüfen / reparieren / ersetzen
Das System wird nicht Verbinden	<ul style="list-style-type: none"> • Sender und Empfänger zu nah gegenseitig • Sender und Empfänger zu nah große Metallobjekte (Fahrzeuge usw.) • Empfänger versehentlich in Verbindung gebracht Modus so Empfänger ist nicht mehr gebunden 	<ul style="list-style-type: none"> • Sender 8-12 Fuß bewegen (2,4-3,6 m) vom Empfänger • Entferne dich von großem Metall Objekte (Fahrzeuge usw.) • Sender neu aufnehmen und Empfänger
Der Empfänger wird been det reagierenWährend der Operation	<ul style="list-style-type: none"> • Niedrige Batteriespannung 	<ul style="list-style-type: none"> • Batterie vollständig aufladen
Empfänger verliert seine Bindung	<ul style="list-style-type: none"> • Sender versehentlich eingesteckt Modus, Ende binden an Empfänger 	<ul style="list-style-type: none"> • Absender an Empfänger Z binden

Garantiebestimmungen



Mit dem Erwerb und Gebrauch Ihres Absima Produkts erklären Sie sich mit den Garantiebestimmungen der Absima GmbH einverstanden.

Die Garantie bezieht sich nur auf bereits beim Kauf des Produktes vorhandene Material- und/oder Funktionsmängel.

Von der Garantie ausgeschlossen sind:

- Schäden durch falsche Anwendung
- Schäden durch Vernachlässigung der Sorgfaltspflicht
- Schäden durch unsachgemäße Behandlung und Wartungsfehler
- Flüssigkeitsschäden

Garantiefälle melden Sie bitte Ihrem Verkäufer/Fachhändler.

Sollte eine Einsendung Ihres Produktes notwendig sein, legen Sie bitte Ihren Kaufbeleg und eine detaillierte Fehlerbeschreibung der Sendung bei. Zudem brauchen wir Ihre kompletten Kontaktdaten (gut leserlich).

Die direkte Zusendung an die Serviceabteilung der Absima GmbH bedarf der vorhergehenden Absprache. Dies kann telefonisch unter +49 911 65084130 oder per E-Mail an service@absima.com erfolgen.

Die anfallenden Portokosten trägt der Versender. Unfreie oder kostenpflichtige Pakete werden nicht angenommen. Jeder eingehende Garantiefall wird zunächst durch unsere Serviceabteilung auf Zulässigkeit geprüft. Für Reklamationen die nicht unter die Garantie fallen, können ggf. Kosten für die Überprüfung anfallen. Reparaturen oder Leistungen die nicht unter die Garantie fallen, berechnen wir per Vorkasse.

Haftungsausschluss

Da die Einhaltung der Bedienungsanleitung, sowie der Betrieb und die Bedingungen zur Verwendung des Produktes zu keiner Zeit von der Absima GmbH überwacht werden kann, übernimmt die Absima GmbH keinerlei Haftung für Schäden, Kosten, Verluste, die sich aus falscher Handhabung und/oder fehlerhaften Betrieb ergeben oder in irgendeiner Weise damit zusammenhängen. Soweit gesetzlich zugelassen, wird die Verpflichtung zur Schadensersatzleistung, aus welchen rechtlichen Begründungen auch immer, auf den Rechnungswert des am Ereignis beteiligten Absima Produkts begrenzt. Dies gilt nicht, soweit wir durch zwingende gesetzliche Vorschriften oder grobe Fahrlässigkeit unbeschränkt haften müssen.

Konformitätserklärung

Hiermit erklärt der Hersteller, dass sich das Produkt in Übereinstimmung mit den grundlegenden Anforderungen und den übrigen einschlägigen Bestimmungen der EU Richtlinie befindet.

Die Konformitätserklärung kann unter

<http://absima.com/index.php/downloads/erklaerungen/>

eingesehen werden oder unter
Absima GmbH – Gibitzenhofstraße 127a/RG – 90443 Nürnberg
angefordert werden.



Entsorgung

Elektronische Altgeräte sind Rohstoffe und gehören nicht in den Hausmüll. Ist das Produkt am Ende seiner Lebensdauer, so entsorgen Sie dieses gemäß den geltenden gesetzlichen Bestimmungen bei Ihren kommunalen Sammelstellen. Eine Entsorgung im Hausmüll oder zu Lasten der Umwelt ist verboten.

Wichtig! Entfernen Sie vor der Entsorgung die Batterien oder den/die Akkus. Für Batterien und Akkus gilt ein getrenntes Rücknahme-System.

Sie leisten mit der fachgerechten Entsorgung Ihrer Altgeräte einen wichtigen Beitrag zum Umweltschutz.

Absima GmbH
Gibitzenhofstraße 127 a / RG
90443 Nürnberg, Deutschland
Tel.: +49 911 65084130 / Fax: +49 911 65084140
www.absima.com



Technische Änderungen, Änderung am Design und an Ausstattung vorbehalten





VOR DEM GEBRAUCH UNBEDINGT LESEN

LADEN

- Verwenden Sie Ladegeräte und Einstellungen, die mit dem Akku, den Sie laden kompatibel sind (NiMH, LiPo...).
 - Bei LiPo Akkus unbedingt Ladegerät mit Balancer-Funktion verwenden
 - Wir empfehlen für alle Akkus einen Ladestrom von maximal 1C (z.B. 4A Ladestrom für einen 4000mAh Akku)
-

ANWENDUNG

- Der Akku muss gut gegen äußerliche Einflüsse und Beschädigungen geschützt sein.
 - Stellen Sie die Abschaltspannung Ihres Fahrtenreglers entsprechend des Akku-Typs und Ihrer verwendeten Elektronik ein.
 - Tiefentladung von LiPo-Akkus führt zur Beschädigung der Zellen. Überlasten Sie den Akku nicht mit zu hohen Lade-/Entladeströmen.
-

WARNUNGEN

- Lassen Sie den Akku während des Lade- und Entladevorgangs niemals unbeaufsichtigt.
- Ladung und Benutzung nur unter unmittelbarer Aufsicht eines Erwachsenen.
- Modifizieren Sie den Akku weder am Gehäuse noch an den Steckern.
- Laden Sie den Akku nur in einem gut belüfteten Raum fern von entflammaren und/oder elektrisch leitenden Materialien
- Sollten während des Ladevorgangs auffällige Gerüche, Verfärbungen, eine große Hitzeentwicklung, austretende Gase/Flüssigkeiten oder Deformationen am Gehäuse entstehen, trennen Sie den Akku sofort vom Ladegerät und lagern Sie ihn an einem sicheren und feuerfesten Ort.
- NiMH Akkus können während des Gebrauchs und Ladevorgangs heiß werden.
- Achten Sie bei der Lagerung von LiPo Akkus über einen längeren Zeitraum darauf, dass die Zellenspannung ca. 3.8V/Zelle beträgt. Ansonsten können die Zellen beschädigt werden.



⚠ Caution

1. Small parts keep away from reach for children under 14 years old.
2. Please operate in an open field without any wave interference.
3. When transmitter is in low power, please stop and change batteries immediately.
4. On back out after the removal, please do not place discarded to avoid contamination sanitation.
5. Please store the car and the transmitter in a dry and cool environment.
6. Keep away from fire, hot or humid environment.
7. If car and battery getting wet, be sure to wipe and dry it completely to avoid any damage.

Product configuration



16007



16008



16020



16021



Remote Control
(Radio)



Manual



USB charging cable



7.4V 1,500mAh rechargeable battery

1. Remove the protection film on truck body

Pull out the pins and remove the body

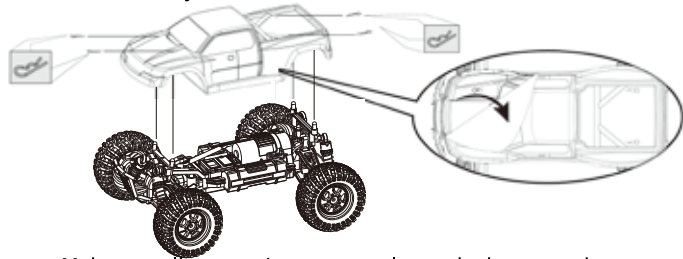

Make sure all accessories are properly attached, remove the protection film from the body before turning on the truck

2. Install Transmitter Batteries

- (1) Remove the battery cover on the bottom of the transmitter (figure 1)
- (2) Install 3 x 1.5V AA batteries (not included) in correct polarities (figure 2)
- (3) Close the battery cover (figure 3)

NOTICE!

When installing batteries, please be sure to match the polarities marked on the battery holder.
Do not mix old and new batteries.
Do not mix different type of batteries.



(figure 1)

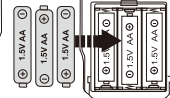

(figure 2)

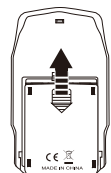

(figure 3)



4. Charge and Install Rechargeable Battery Pack

- (1)a) Insert the USB charger into the outlet (figure 4) note the power light turns red .
- b)Connect the battery pack to the USB charger (figure 5) note the green light flashes.
- c)When charging is completed , green light turns solid.

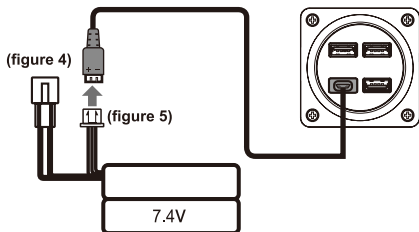

- (3).Place your fully charged battery in the battery slot. connect the battery connector. Don't force it,it only goes one way! (figure 7)

Power Switch

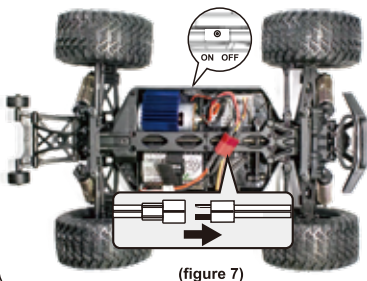

(figure 7)

- (2) Loosen the Velcro Tape of the battery on chassis then remover it (figure 6)

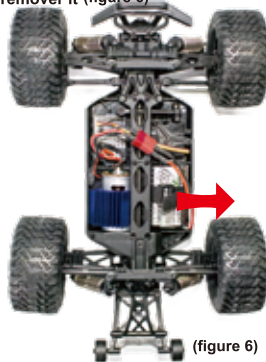

(figure 6)

- (4) Put back the battery and tighten the velcro tape (figure 8)



(figure 8)

5.USB Charger Precautions



CAUTION

- (1).The USB charger does not apply the input current bigger than 2.4A
- (2).When input current is bigger than 2.4A, the USB charger will start-up protection mode ,all the lights will turn off.

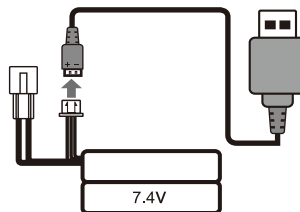

6 Transmitter instructions



- A.Power Switch
 B.Steering Trim
 C:Throttle trim
 (low speed to high speed)

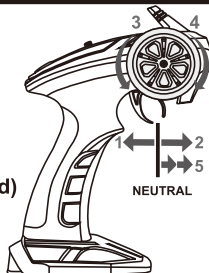

- 1.Forward
- 2.Brake
- 3.Left
- 4.Right
- 5.Backward



(1) Green LED



(2) Red LED

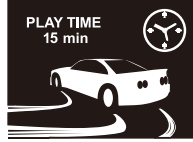

1. Turn on the power switch on the transmitter, green LED will turn solid and red LED will flash,
2. When pairing successful with the car, red LED will turn solid.

Green LED will flash when power is low on the transmitter, please replace the batteries before continuing

7. Transmitter switch instructions

A. Power Switch

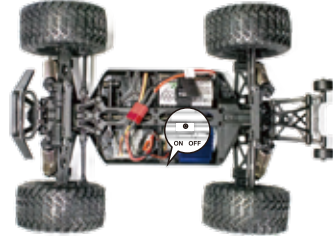
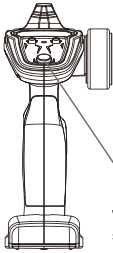

When pairing for the first time, both of the car and transmitter have to be turned on within 3 seconds to pair the frequency. Red LED on the transmitter will solid when pairing successful, on the same time LED on the car will turn solid.

B. Steering Trim

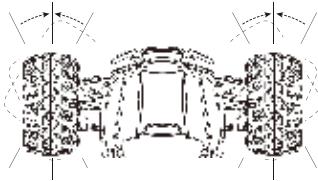
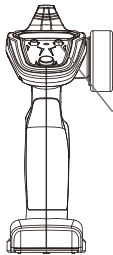

When the chassis switch is turned on and the front tires are not straight, use the ST.TRIM to adjust the position.

- When the car oversteers to the left, ST.TRIM should be adjusted clockwise.
- When the car oversteers to the right, ST.TRIM should be adjusted anticlockwise.

C. Throttle trim

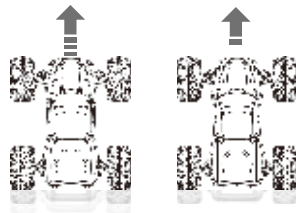
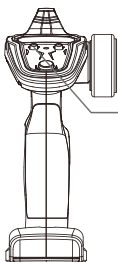

H
(High speed)

L
(Low speed)

SUGGEST: Please adjust the "SPEED" to the low speed when you play with the car for the first time to avoid damaging the car !



OPERATION

1. ALWAYS turn on your transmitter before you turn on the receiver in the vehicle. Always power off the receiver before turning your transmitter off.



2. ALWAYS operate your vehicle in a wide open area. Operating the vehicle on slippery floor or indoors may crash because of the high speed.

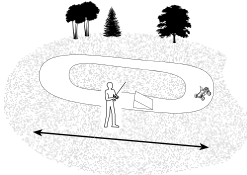

3. WARNING:16001, 16002, 16003, 16004, 16005, 16006 waterproof feature, please be cautious that the water level should be lower than the bottom of the truck. If excessive amount of water gets into the body of the truck and cause damage or other related problems, We will not be responsible for such damages. Customers will be responsible for any replacements and additional accessories if needed.



4. ALWAYS start with low speed, or the vehicle may slip or run on curves. (as shown on Pic 1) NEVER operate your vehicle in max speed. Operating the vehicle in highest speed may hurt yourself and damage your vehicle.

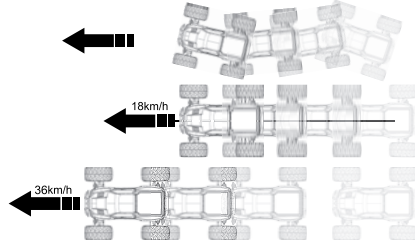
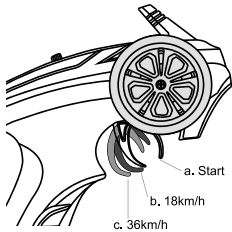

MOTOR CARE

- Seat the motor brushes by driving smoothly on a flat surface during use of the first battery charge. Failing to do so can greatly reduce motor performance and functional life.
- Prolong motor life by preventing overheating conditions. Undue motor wear results from frequent turns, stops and starts, pushing objects, driving in deep water and tall grass, and driving continuously up hill.

TROUBLESHOOTING

Problem	Possible Cause	Solution
Short run time	<ul style="list-style-type: none"> • Battery damaged/not charged • Motor dirty or brushes worn 	<ul style="list-style-type: none"> • Check/change battery • Check/clean/replace
Sluggish action	<ul style="list-style-type: none"> • Motor dirty or brushes worn • Bind in drivetrain • Vehicle battery is not charged 	<ul style="list-style-type: none"> • Check/clean/replace • Clean/adjust • Replace/recharge
Do not operate	<ul style="list-style-type: none"> • Transmitter batteries low • Transmitter powered off • Vehicle battery is not charged 	<ul style="list-style-type: none"> • Replace/recharge • Power On • Replace/recharge
Poor range	<ul style="list-style-type: none"> • Low transmitter batteries • Receiver antenna damaged 	<ul style="list-style-type: none"> • Replace/recharge • Check/repair/replace
The system will not Connect	<ul style="list-style-type: none"> • Transmitter and receiver too near each other • Transmitter and receiver too near large metal objects (vehicles, etc.) • Receiver accidentally put in bind mode so receiver is no longer bound 	<ul style="list-style-type: none"> • Move transmitter 8–12 feet (2.4–3.6m) from receiver • Move away from large metal objects (vehicles, etc.) • Rebind transmitter and receiver
The receiver quits responding During operation	<ul style="list-style-type: none"> • Low battery voltage 	<ul style="list-style-type: none"> • Completely recharge battery
Receiver loses its bind	<ul style="list-style-type: none"> • Transmitter accidentally put in bind mode, ending bind to receiver 	<ul style="list-style-type: none"> • Bind transmitter to receiver

Warranty Terms



By purchasing and using your Absima product, you agree to the warranty terms of Absima GmbH.

The warranty applies only to material and/or functional defects already present at the time of purchase of the product.

Excluded from the guarantee:

- Damage caused by incorrect use
- Damage due to neglect of duty of care
- Damage due to improper handling and maintenance errors
- Fluid damages

Please report warranty claims to your dealer.

If it is necessary to return your product, please enclose your proof of purchase and a detailed description of the fault with the shipment. We also need your complete contact details (legible).

The direct sending to the service department of Absima GmbH requires the previous arrangement. This can be done by telephone under +49 911 65084130 or by e-mail to service@absima.com

The shipping costs are borne by the sender. Parcels that are not free of charge or are subject to charges will not be accepted.

Each incoming warranty case is first checked by our service department for admissibility. Complaints that are not covered by the warranty may incur costs for the inspection. Repairs or services that are not covered by the warranty will be charged in advance.

Disclaimer

Since Absima GmbH cannot at any time monitor the observance of the operating instructions as well as the operation and conditions of use of the product, Absima GmbH does not assume any liability for damages, costs, losses resulting from incorrect handling and/or incorrect operation or in any way related thereto. To the extent permitted by law, the obligation to pay damages, for whatever legal reason, will be limited to the invoice value of the Absima product involved in the event. This does not apply as far as we have to assume unlimited liability due to mandatory legal regulations or gross negligence.

Declaration of conformity

The manufacturer hereby declares that the product complies with the essential requirements and other relevant provisions of the EU Directive.

The declaration of conformity can be found at

<http://absima.com/index.php/downloads/erklaerungen/>

or can be consulted under

Absima GmbH - Gibitzenhofstrasse 127a/RG - 90443 Nuremberg, Germany can be requested.



Disposal

Waste electronic equipment is a raw material and should not be disposed of with household waste. If the product is at the end of its service life, dispose of it at your local collection points in accordance with the applicable legal regulations. Disposal with household waste or at the expense of the environment is prohibited.

Important! Remove the batteries or rechargeable batteries before disposal. A separate take-back system applies to batteries and rechargeable batteries.

By properly disposing of your old appliances, you make an important contribution to environmental protection.

Absima GmbH
Gibitzenhofstrasse 127 a / RG
90443 Nürberg , Germany
Phone: +49 911 65084130 / Fax: +49 911 65084140
www.absima.com



Technical changes, design and equipment subject to change without notice.



READ CAREFULLY BEFORE USE

STORE

- Use chargers and settings that are compatible with the battery you are charging (NiMH, LiPo ...).
 - Always use a charger with balancer function for LiPo batteries.
 - We recommend a maximum charge current of 1C for all batteries (e.g. 4A charge current for a 4000mAh battery).
-

APPLICATION

- The battery must be well protected against external influences and damage.
 - Set the cut-off voltage of your speed controller according to the type of battery and the electronics used.
 - Deep discharge of LiPo batteries will damage the cells.
 - Do not overload the battery with excessive charge/discharge currents.
-

WARNINGS

- Never leave the battery unattended during charging and discharging.
- Charge and use only under the direct supervision of an adult.
- Do not modify the battery either on the housing or on the plugs.
- Only charge the battery in a well-ventilated room away from flammable and/or electrically conductive materials.
- If noticeable odors, discoloration, excessive heat, escaping gases/liquids or deformation of the housing occurs during charging, disconnect the battery immediately from the charger and store it in a safe and fireproof place.
- NiMH batteries can become hot during use and charging.
- When storing LiPo batteries over a long period of time, ensure that the cell voltage is approx. 3.8V/cell. Otherwise the cells may be damaged.

⚠ ATTENTION

1. Contient de petites pièces. Tenir hors de portée des enfants
2. N'utilisez votre véhicule que sur un terrain ouvert et bien visible En cas de faible puissance d'émission, arrêter immédiatement le véhicule et remplacer les batteries
3. Conserver le véhicule dans un environnement sec et frais
4. Éloignez le véhicule du feu, de l'environnement chaud ou humide
5. Assurez-vous que le véhicule et la batterie soient toujours secs pour éviter les dommages

CONFIGURATION DU PRODUIT



16007



16008



16020



16021



Télécommande



Instructions



Câble de charge USB



Batterie 7.4V 1,500mAh

1. DEMONTAGE DE LA CARROSSERIE

Enlevez les clips et enlevez la carrosserie

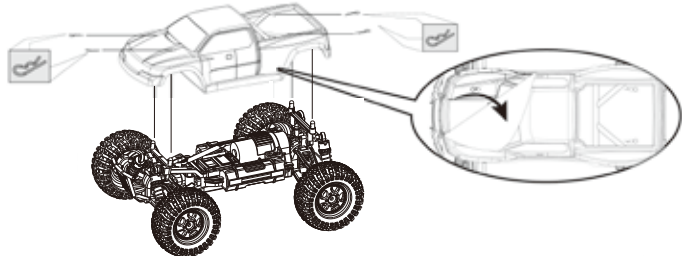

Assurez-vous que tous les accessoires soient correctement placés.
Retirez le film de protection de la carrosserie avant utilisation.

2. INSTALLATION DES BATTERIES

- (1) Retirez le couvercle de la batterie.
- (2) Installez des batteries 3x1.5V AA (non incluses dans le volume de livraison) et
- (3) fermez le couvercle.

ATTENTION!

Faites attention à la bonne polarité comme indiqué.
Ne mélangez pas les anciennes et les nouvelles batteries. Ne mélangez pas différents types de batteries



(figure 1)

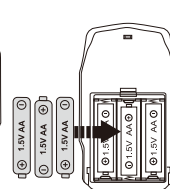

(figure 2)

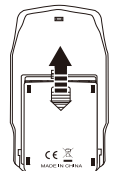

(figure 3)

4. CHARGEMENT ET INSTALLATION DES BATTERIES RECHARGEABLES

- (1) a) Placez le chargeur USB dans la prise (figure 4) - la DEL devient rouge.
- b) Raccordez la batterie au chargeur USB (figure 5)
- c) Le chargement est terminé lorsque la LED verte est allumée en permanence.

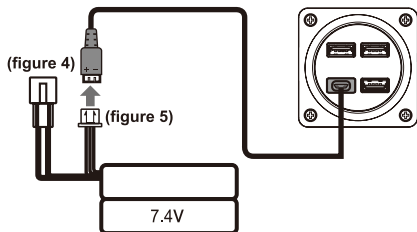

- (3) Placez la batterie correctement chargée dans son compartiment. Branchez les connecteurs. Ne pas forcer – sens unique (figure 7)

Power Switch

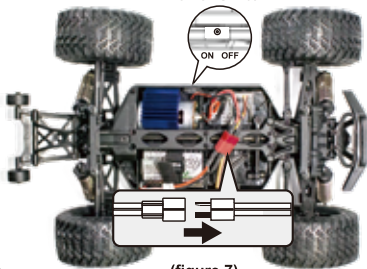

(figure 7)

- (2) Desserrez la bande Velcro de la batterie sur le châssis puis retirez-la (figure 6)

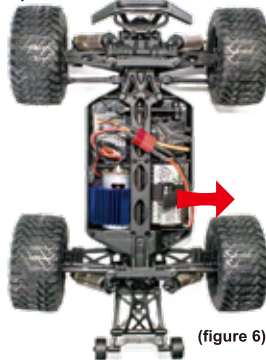

(figure 6)

- (4) Remettez la batterie et serrez la bande velcro (figure 8)

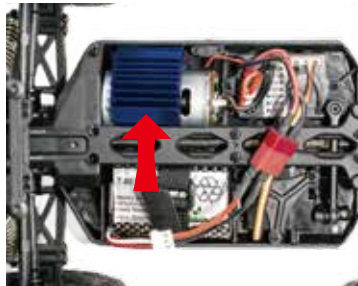

(figure 8)

5. PRECAUTIONS DE CHARGEMENT EN USB

! **ATTENTION!**

- (1) Ne pas utiliser de source d'énergie pour le chargeur USB dont la capacité est supérieure à 2.4A
2. Si le courant d'entrée est supérieur au 2.4A, un mode de protection commence automatiquement et toutes les LED s'éteignent

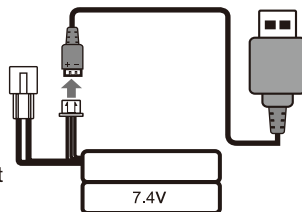

A. MARCHE/ARRET
B. TRIM DE DIRECTION
C. TRIM DE GAZ
 (lent à rapide)

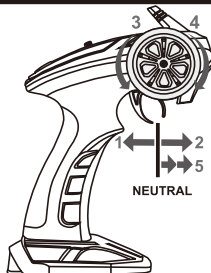

1. Marche Avant
2. Freinage
3. Gauche
4. Droite
5. Marche Arrière

(1) Green LED



(2) Red LED



1. Allumez la télécommande. La LED verte brille et la LED verte clignote.

2. Lorsque la liaison entre la voiture et la télécommande est établie, la LED rouge brille de manière permanente.



Si la LED verte clignote pendant le fonctionnement, la batterie est vide. Changez-la avant de poursuivre

7. INSTRUCTIONS DE MISE EN FONCTION DE LA RADIO

A. Power Switch

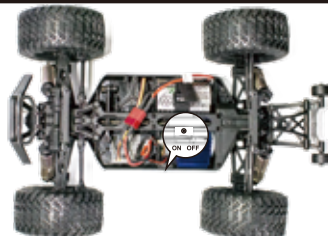

Lors de la première connexion, la voiture et la radio doivent être dans un délai de 3 secondes pour coupler la fréquence. La LED verte sur l'émetteur et la LED sur le récepteur du véhicule sont allumées de manière permanente.

B. Steering Trim

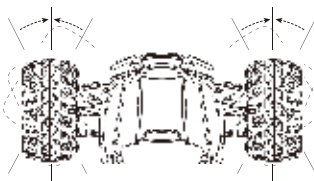
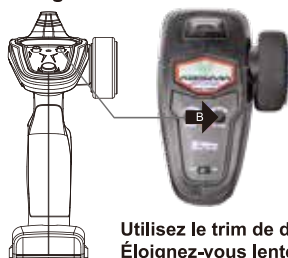

Utilisez le trim de direction pour régler la marche en ligne droite du véhicule. Éloignez-vous lentement de vous et tournez le régulateur jusqu'à ce que le véhicule roule en ligne droite.

C. Throttle trim

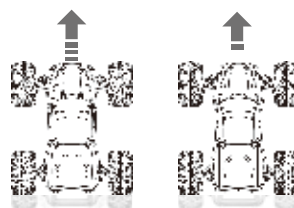
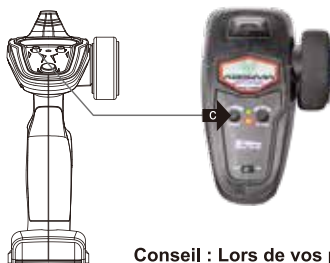

H
(High speed)

L
(Low speed)

Conseil : Lors de vos premières utilisations, réglez le trim de gaz au minimum le temps de s'habituer à la conduite et évitez tout accident!!!



UTILISATION

1. Allumez le transmetteur d'abord et le véhicule ensuite. Éteignez d'abord le véhicule, puis le récepteur



2. N'utilisez votre véhicule que sur un terrain ouvert et bien visible.

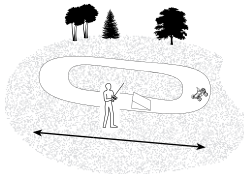

3. ATTENTION : Assurez-vous que le niveau de l'eau soit inférieur au plancher du véhicule. Si de l'eau arrive à l'intérieur du véhicule, cela peut causer les dommages dont vous êtes responsable.

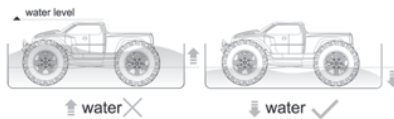

4 Démarrez toujours lentement et habitez-vous au véhicule avant de vous mettre à pleine vitesse.

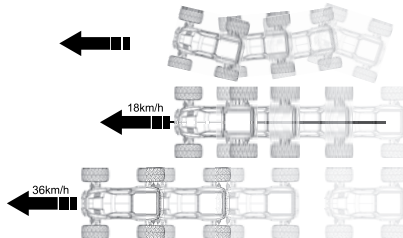
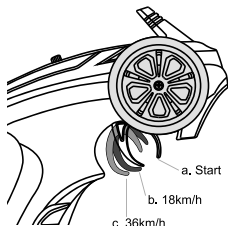

PRECAUTIONS MOTEUR

Rodez votre moteur par une utilisation sur sol plat et de manière douce la première fois au risque d'endommager celui-ci. Prolonger la durée de vie de votre moteur en évitant toute surchauffe. Celle-ci résulte de virages fréquents, arrêts et démarrages brusques, déplacement d'objets, conduite en eau profonde et herbes hautes ainsi que les accélérations en côte trop longues.

DEPANNAGE

SYMPTOMES	CAUSES POSSIBLES	SOLUTION
Temps de roulage limité	Batterie endommagée/non changée Moteur sale ou obstrué	Vérifier/changer la batterie Vérifier/Nettoyer/Remplacer
Ralentissement du véhicule	Moteur sale ou obstrué Appuyer sur la gachette Batterie non chargée	Vérifier/Nettoyer/Remplacer Nettoyer/Régler Remplacer/Recharger
Vehicule ne répondant pas	Batterie radio trop faible Radio éteinte Batterie du véhicule non chargée	Remplacer/Recharger Allumer Remplacer/Recharger
Mauvaise portée	Batterie radio trop faible Antenne radio endommagée	Remplacer/Recharger Vérifier/Réparer/Remplacer
Pas de connexion	Radio et récepteur trop près Radio et récepteur proches d'un gros objet métallique (voiture,...) Récepteur en mode connexion par erreur, le récepteur n'est plus reconnu	Placer la radio à 2 - 3 mètres du récepteur S'éloigner de l'objet (véhicule,...) Recommencer le bindage de la radio et du récepteur
Plus de réponse du récepteur pendant l'utilisation	Batterie trop faible	Recharger complètement la batterie
Perte d'appairage	Récepteur en mode connexion par erreur, le récepteur n'est plus reconnu	Recommencer le bindage de la radio et du récepteur

Conditions de garantie

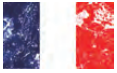

En achetant et en utilisant votre produit Absima, vous acceptez les conditions de garantie de Absima GmbH.

La garantie ne s'applique qu'aux défauts matériels et/ou fonctionnels déjà présents au moment de l'achat du produit.

Exclus de la garantie :

- Dommages causés par une utilisation incorrecte
- Dommages dus à la négligence d'un devoir de diligence
- Dommages dus à des erreurs de manipulation et d'entretien
- dégât des fluides

Veillez signaler les demandes de garantie à votre revendeur.

S'il est nécessaire de retourner votre produit, veuillez joindre votre preuve d'achat et une description détaillée du défaut à l'envoi. Nous avons également besoin de vos coordonnées complètes (lisibles).

L'envoi direct au service après-vente d'Absima GmbH nécessite l'accord préalable. Vous pouvez le faire par téléphone au +49 911 65084130 ou par e-mail à service@absima.com

Les frais d'expédition sont à la charge de l'expéditeur. Les colis non gratuits ou payants ne seront pas acceptés.

Chaque cas de garantie reçu est d'abord vérifié par notre département de service pour la recevabilité. Les plaintes qui ne sont pas couvertes par la garantie peuvent entraîner des frais d'inspection. Les réparations ou services qui ne sont pas couverts par la garantie seront facturés à l'avance.

Clause de non-responsabilité

Comme Absima GmbH ne peut à aucun moment contrôler le respect du mode d'emploi ainsi que le fonctionnement et les conditions d'utilisation du produit, Absima GmbH n'assume aucune responsabilité pour les dommages, coûts, pertes résultant d'une mauvaise manipulation et/ou d'une mauvaise utilisation ou de toute autre manière y étant liée. Dans la mesure permise par la loi, l'obligation de payer des dommages-intérêts, pour quelque raison légale que ce soit, sera limitée à la valeur de la facture du produit Absima impliqué dans l'événement. Ceci ne s'applique pas dans la mesure où nous devons assumer une responsabilité illimitée en raison de dispositions légales obligatoires ou de négligence grave.

Déclaration de conformité

Le fabricant déclare par la présente que le produit est conforme aux exigences essentielles et aux autres dispositions pertinentes de la directive européenne.

La déclaration de conformité peut être consultée à l'adresse suivante



<http://wp.absima.com/index.php/downloads/erklarungen/>

ou peut être consulté sous

Absima GmbH - Gibitzenhofstrasse 127a/RG - 90443 Nuremberg, Allemagne
peut être demandée.



Élimination

Les déchets d'équipements électroniques sont une matière première et ne doivent pas être jetés avec les déchets ménagers. Si le produit a atteint la fin de sa durée de vie utile, jetez-le dans vos points de collecte locaux conformément aux réglementations légales en vigueur. L'élimination avec les ordures ménagères ou au détriment de l'environnement est interdite.

Important ! Retirez les piles ou les accumulateurs avant de les jeter. Un système de reprise séparé s'applique aux batteries et aux batteries rechargeables.

En vous débarrassant correctement de vos vieux appareils électroménagers, vous contribuez de manière importante à la protection de l'environnement.

Absima GmbH
Gibitzenhofstrasse 127 a / RG
90443 Nürberg, Allemagne
Téléphone : +49 911 65084130 / Fax : +49 911 65084140
www.absima.com



Sous réserve de modifications techniques, de conception et d'équipement.



LIRE ATTENTIVEMENT AVANT L'UTILISATION

STORE

- Utilisez des chargeurs et des réglages compatibles avec la batterie que vous chargez (NiMH, LiPo ...).
 - Utilisez toujours un chargeur avec fonction d'équilibrage pour les batteries LiPo
 - Nous recommandons un courant de charge maximum de 1C pour toutes les batteries (par exemple, un courant de charge de 4A pour une batterie de 4000mAh)
-



DEMANDE

- La batterie doit être bien protégée contre les influences extérieures et les dommages.
 - Réglez la tension de coupure de votre régulateur de vitesse en fonction du type de batterie et de l'électronique utilisée.
 - La décharge profonde des batteries LiPo endommagera les cellules.
 - Ne surchargez pas la batterie avec des courants de charge/décharge excessifs.
-

ATTENTION

- Ne laissez jamais la batterie sans surveillance pendant la charge et la décharge.
- Ne chargez et utilisez que sous la surveillance directe d'un adulte.
- Ne modifiez pas la batterie, ni sur le boîtier, ni sur les prises.
- Ne chargez la batterie que dans une pièce bien ventilée, à l'écart de matériaux inflammables et/ou conducteurs d'électricité.
- Si des odeurs, une décoloration, une chaleur excessive, des gaz/liquides qui s'échappent ou une déformation du boîtier se produisent pendant la charge, débranchez immédiatement la batterie du chargeur et rangez-la dans un endroit sûr et à l'épreuve du feu.
- Les piles NiMH peuvent devenir chaudes pendant l'utilisation et la charge.
- Lorsque vous stockez des batteries LiPo sur une longue période, assurez-vous que la tension de la cellule est d'environ 3,8V/cellule. Sinon, les cellules peuvent être endommagées.

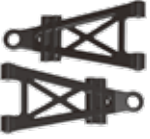
ERSATZTEILE / SPARE PARTS

			
ABZ86101-01 Chassis Plate - Mini AMT	ABZ86101-02 Upper Deck - Mini AMT	ABZ86101-03 Gear Box - Mini AMT	ABZ86101-04 Rear Upper Suspension Bar(2)
			
ABZ86101-05 Front Lower Suspension Arm(2)	ABZ86101-06 Rear Lower Suspension Arm(2)	ABZ86101-07 Front Shock Mount - Mini AMT	ABZ86101-08 Rear Shock Mount - Mini AMT
			
ABZ86101-09 Front Upper Suspension Bar(2)	ABZ86101-10 Body Clips - Mini AMT (6)	ABZ86101-11 Front Bumper - Mini AMT	ABZ86101-12 Rear Bumper - Mini AMT
			
ABZ86101-13 Steering Knuckles l/r - Mini AMT	ABZ86101-14 Rear Axle Block - Mini AMT (2)	ABZ86101-15 Rear Drive Shaft - Mini AMT(2)	ABZ86101-16 Ball Heads - Mini AMT (12)
			
ABZ86101-17 Motor - Mini AMT	ABZ86101-18 RX/ESC Unit - Mini AMT	ABZ86101-19 Heat Sink - Mini AMT	ABZ86101-20 Radio Unit - Mini AMT
			
ABZ86101-21 Servo incl. Bracket - Mini AMT	ABZ86101-22 Wheel Set - Mini AMT (2)	ABZ86101-23 Shock Absorber - Mini AMT (2)	ABZ86101-24 Body Mount - Mini AMT (2)

ERSATZTEILE / SPARE PARTS

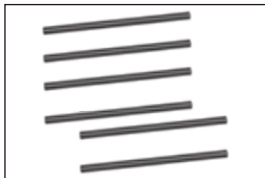

ABZ86101-25
Lower Arm Shaft - Mini AMT(6)

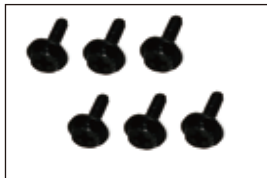

ABZ86101-26
Flange Hex Screw - Mini AMT (6)



ABZ86101-27
Gear Differential f/r Mini AMT



ABZ86101-28
Front Wheel Drive Shafts (2)



ABZ86101-29GB
Body green/yellow - Mini AMT



ABZ86101-29BB
Body blue/pink - Mini AMT



ABZ86101-30
Main Drive Shaft - Mini AMT



ABZ86101-31
USB Charger - Mini AMT

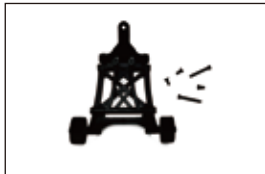

ABZ86101-32
Wheelie Bar - Mini AMT



ABZ86101-33
Battery Strap - Mini AMT

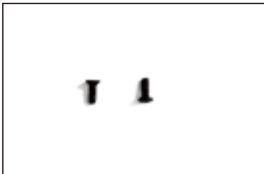

ABZ86101-34 Flat Head
Phillips Screw 2.5*8 (10)

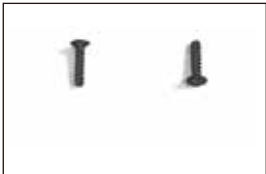

ABZ86101-35 Flat Head
Phillips Screw 2*10 (10)

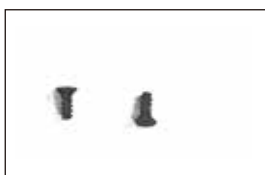

ABZ86101-36 Flat Head
Phillips Screw 2.5*6 (10)

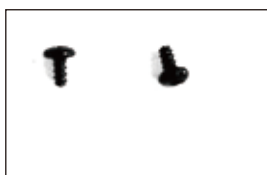

ABZ86101-37 Self-tapping
Phillips Screw 2*4 (10)

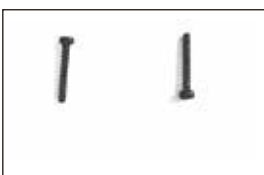

ABZ86101-38 Self-tapping
Phillips Screw 2*12 (10)

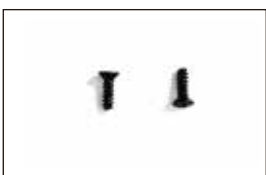

ABZ86101-39 Self-tapping
Phillips Screw 2.5*8 (10)



ABZ86101-40 Self-tapping
Phillips Screw 2.5*15 (10)



ABZ86101-41 Self-tapping
Phillips Screw 2.5*18 (10)



ABZ86101-42 Flange Hex
Screw 2.6*10 - Mini AMT (10)



ABZ86101-43 Self-tapping
Phillips Screw 2.5*8 (10)

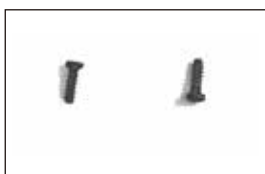

ABZ86101-44 Self-tapping
Phillips Screw 2.6*8 (10)

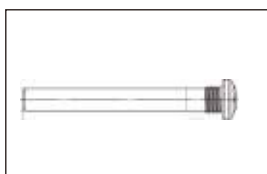

ABZ86101-45 Swing Arm
Shaft Screw 2.5*23 (10)

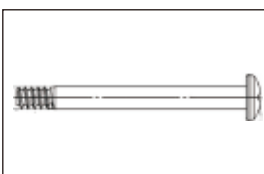

ABZ86101-46 Shock Shaft
Screw 2.5*30 - Mini AMT (10)



ABZ86101-47
Li-Ion Battery 1.500mAh

ERSATZTEILE / SPARE PARTS



ABZ86101-48
Steering Module - Mini AMT



ABZ86101-49
Ball Bearings 9.5*6.3*3.1 (4)



ABZ86101-50
Ball Bearings 12.7*8*4 (4)



ABZ86101-50PG
Truggy Body - Pink/Grey

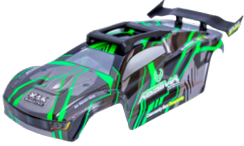

ABZ86101-50GG
Truggy Body - Green/Grey

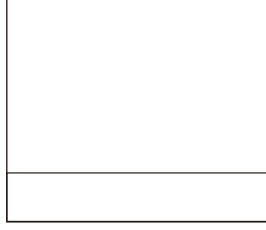
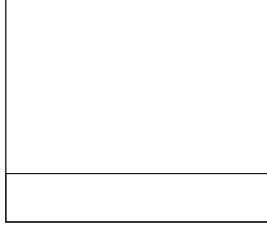
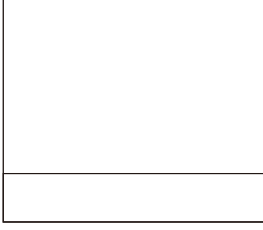
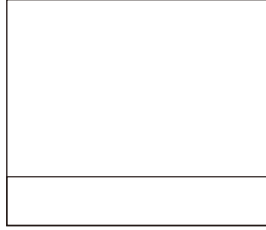
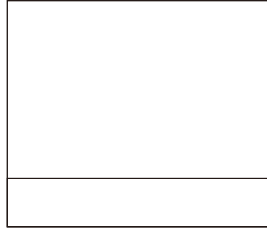

EXPLODED VIEW-1

Diff. Assembly



Lubricate the gears before assembled.



Diff. Assembly Complete
Front & Rear

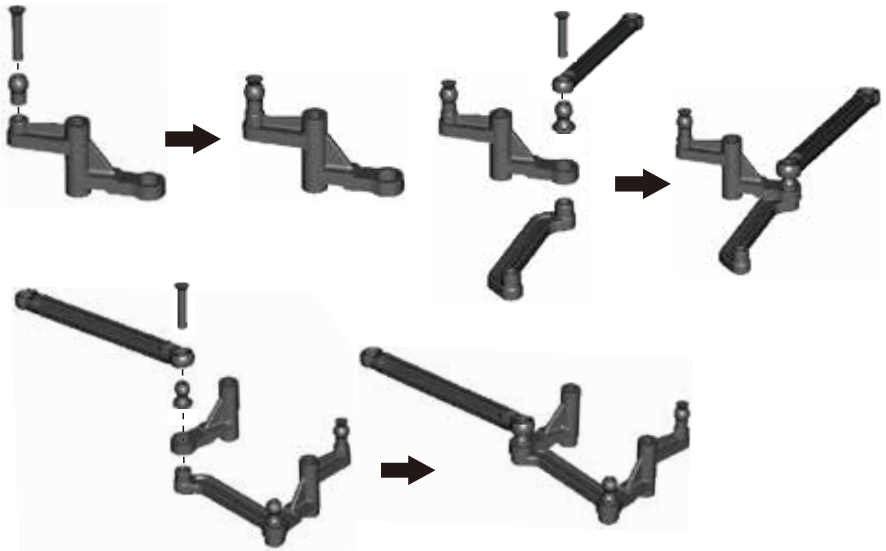

Steering Post Assembly

EXPLODED VIEW-2

Suspension Assembly

Front and Rear

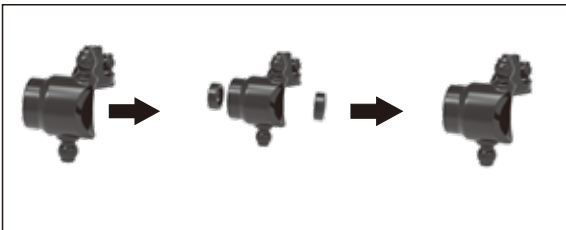
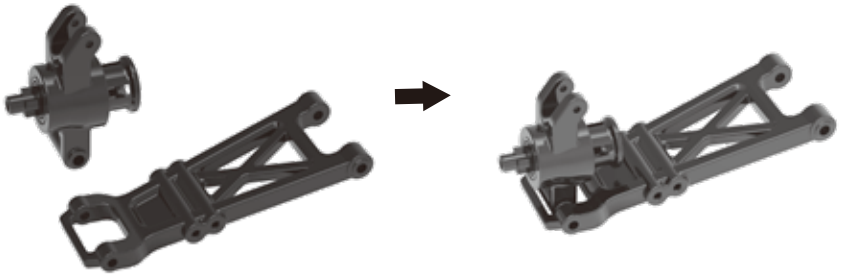
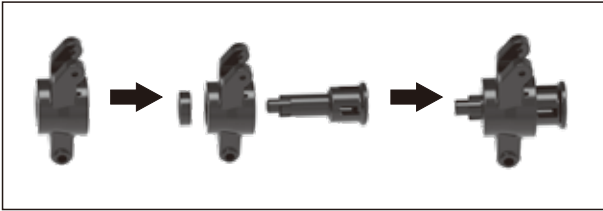

EXPLODED VIEW-3

Main Unit Assembly

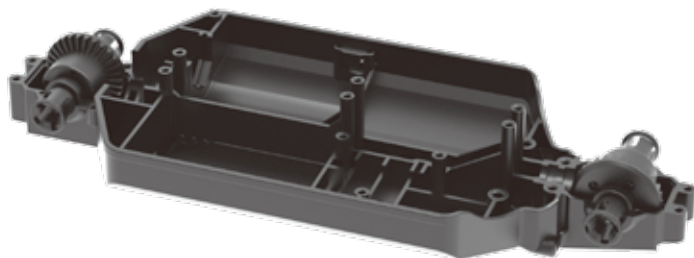
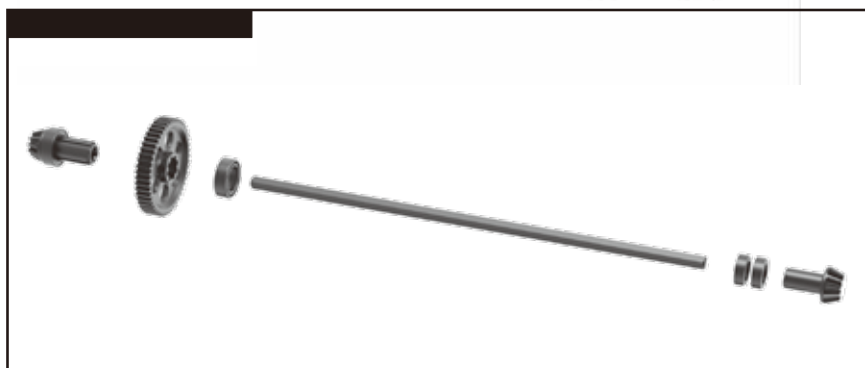

EXPLODED VIEW-4

Main Unit Assembly

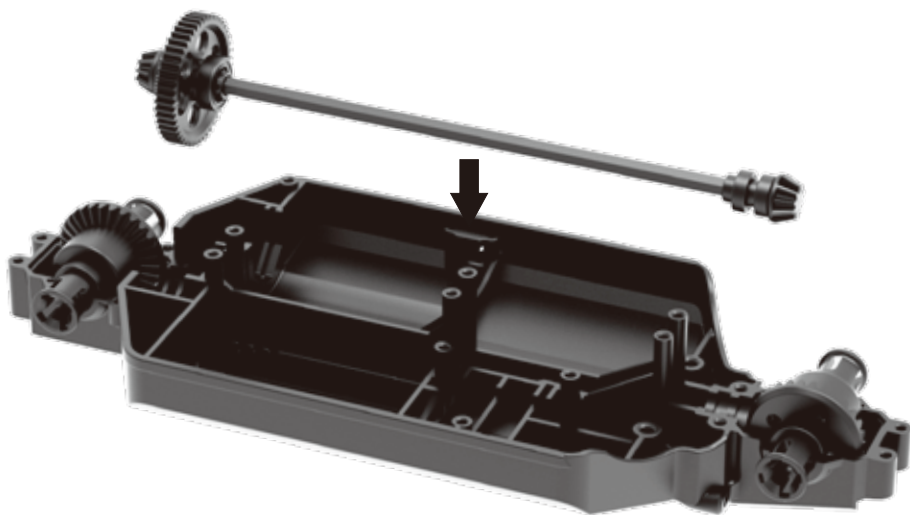

Servo Saver Assembly

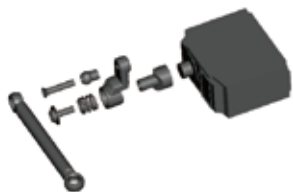

Main Unit Assembly



EXPLODED VIEW-5

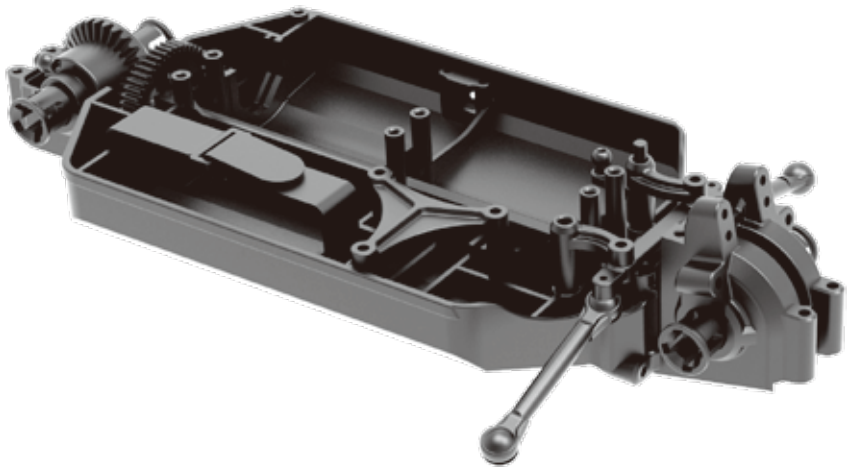

EXPLODED VIEW-6

Main Unit Assembly

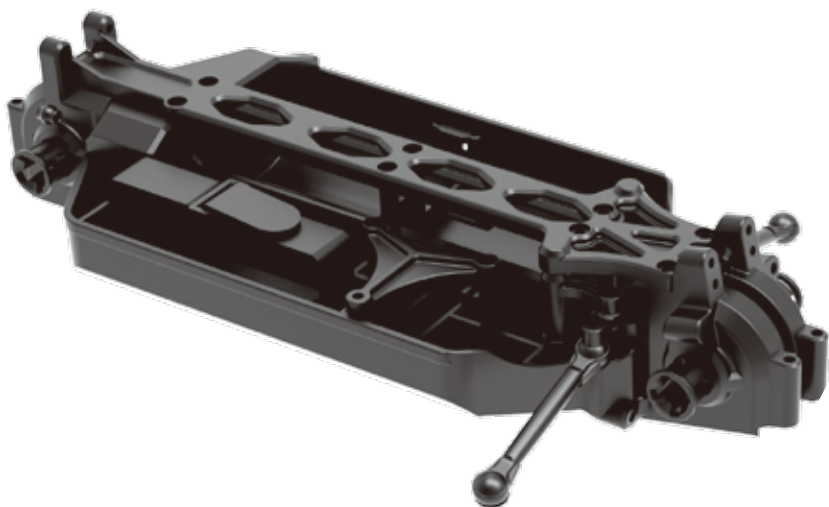
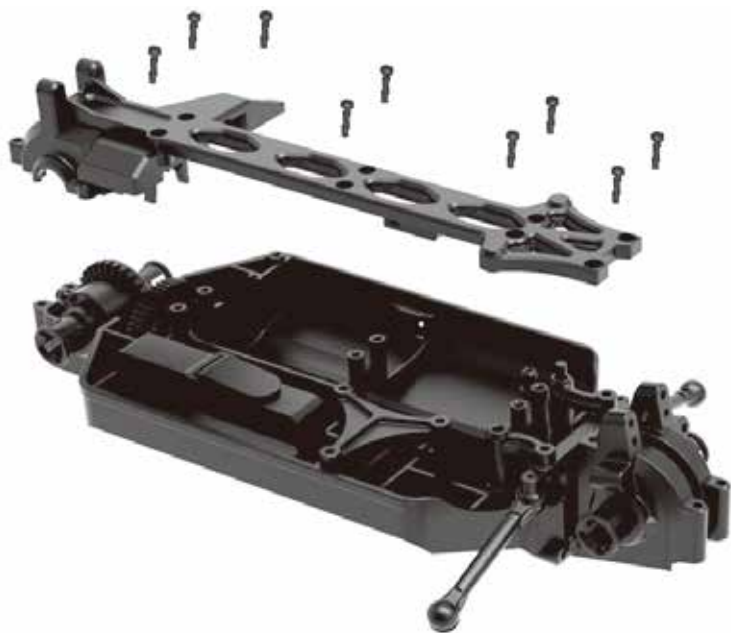

EXPLODED VIEW-7

Main Unit Assembly

Shock Tower/Body Post Assembly(Front)

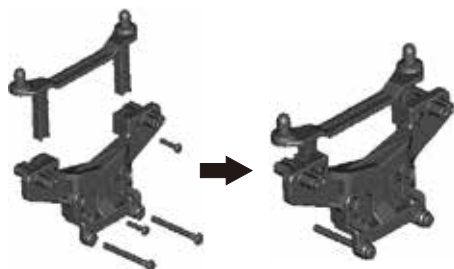
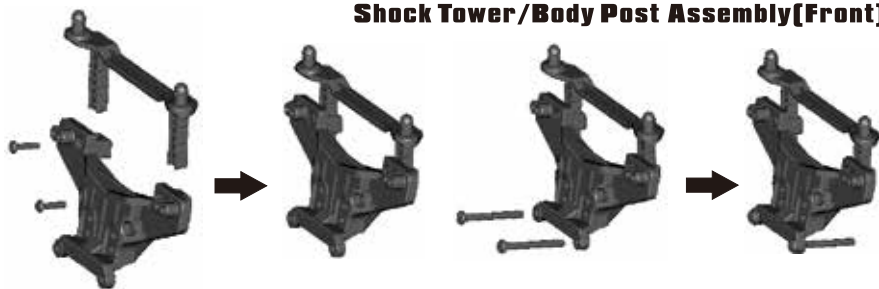

Shock Tower/Body Post Assembly(Rear)



EXPLODED VIEW-8

Main Unit Assembly

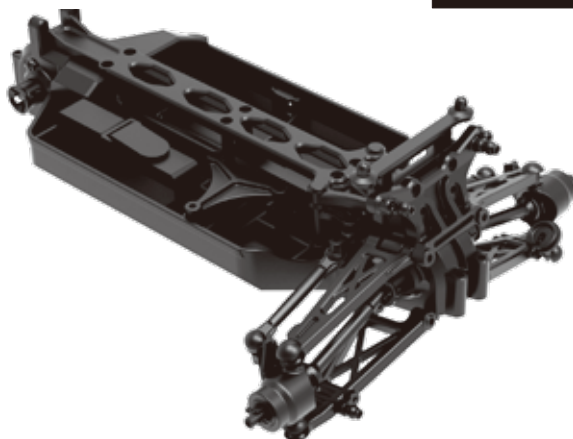

Bumper Assembly [Front and Rear]



EXPLODED VIEW-9

Main Unit Assembly

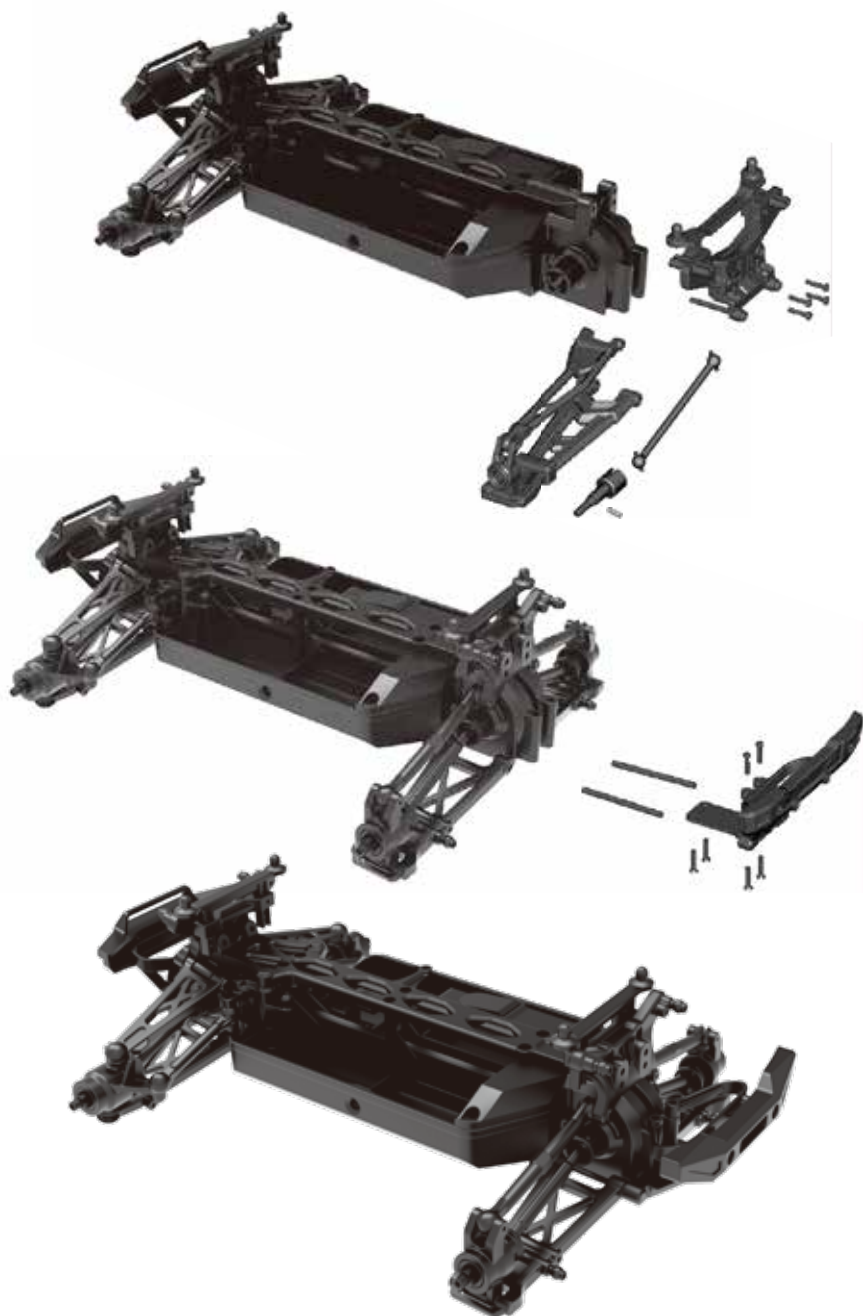

EXPLODED VIEW-10

Main Unit Assembly

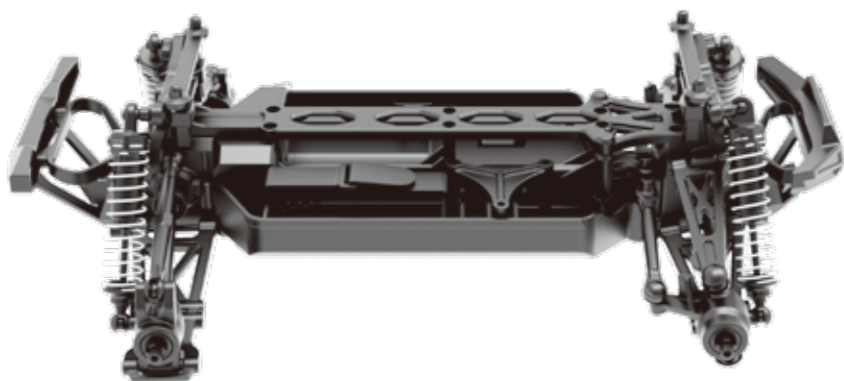

EXPLODED VIEW-11

Main Unit Assembly

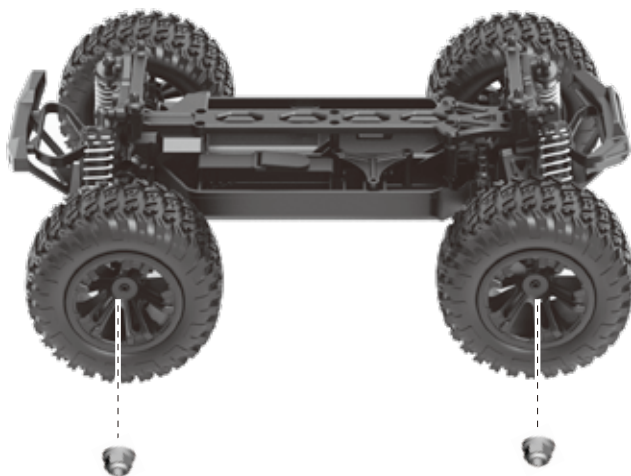



ABSiMA

**Absima GmbH
Gibitzenhofstr. 127a RG
90443 Nürnberg
Germany**

Web: www.absima.com